

RFFE - XRECEIVER (XCVRO_RF) (XCVR1_RF)

(XRCEIVER 071)

IPHONE 7 INTEL

APN: 820-00189-A

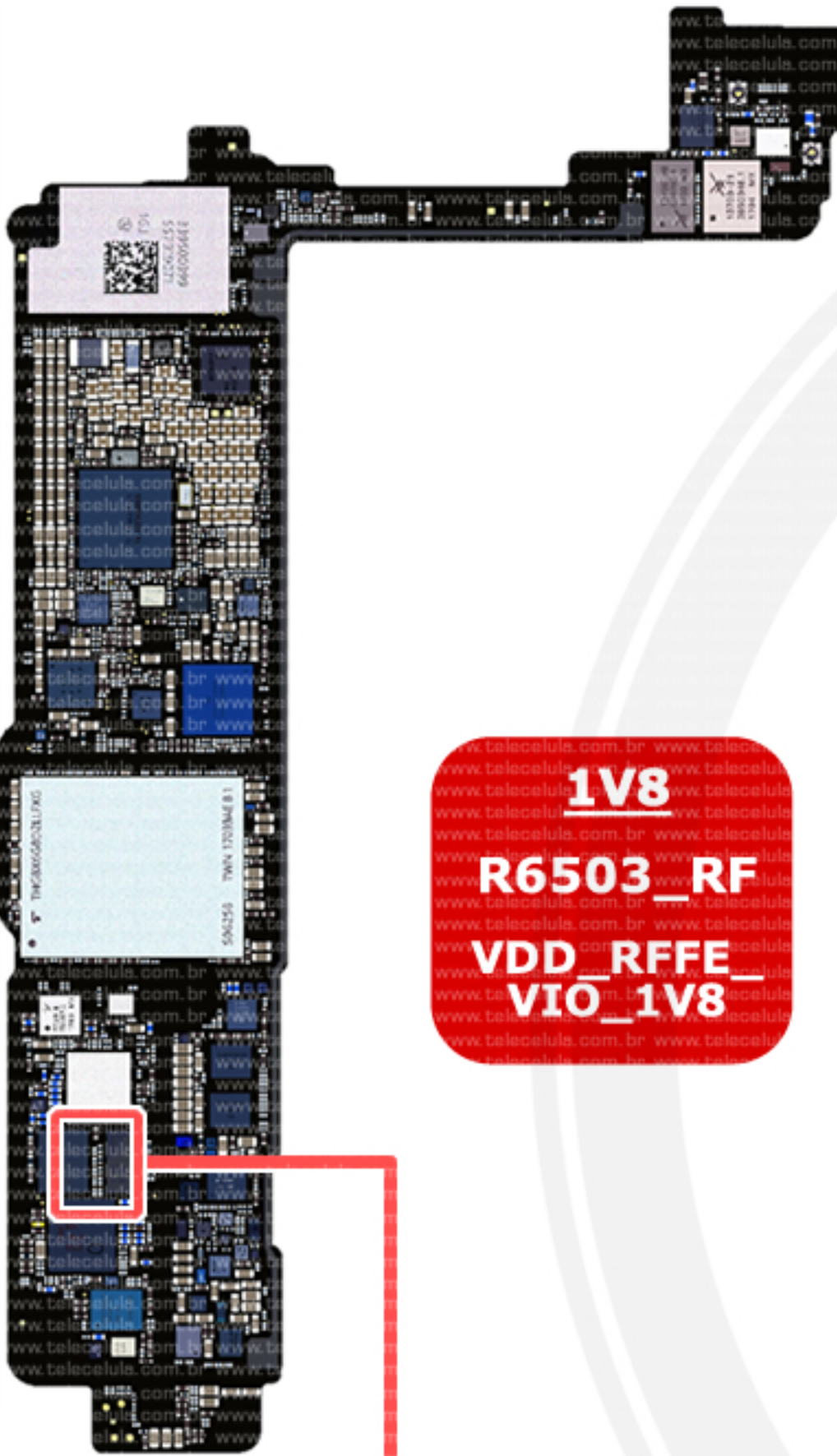

1V8
R6503_RF
VDD_RFFE_VIO_1V8

RFFE1	SKY77359
GSM PA RF	2G PA 0x5
	MB HB TDD SPAD
TDD PA RF	4G 0xF
	QM81003M
ET RF	ENVELOPE 0xC
	MB HB S PAD
MBHBPA RF	0xE
	D513
MB HB DRX ASM	0xA
LATCP RF	DUAL COUPLER 0x6
UATCP_RF	0x7
	RF6110
LBPA_RF	LB S_PAD 0xD
GPIO	0x8
	D5325
LB DRX_ASM	0x9

RFFE2	SKY13703-19
MHBLN_RF	0x3
	VDD_RFFI_VIO_1V8
	SKY13702-17
LBLN_RF	0x2
	VDD_RFFE_VIO_1V8
TUNFX_RF	Flex
	PP1V8_SDRAM

Necessary test points to read RFFE

- SLCK
- SDATA
- GND
- VDD_RFFE_VIO_1V8

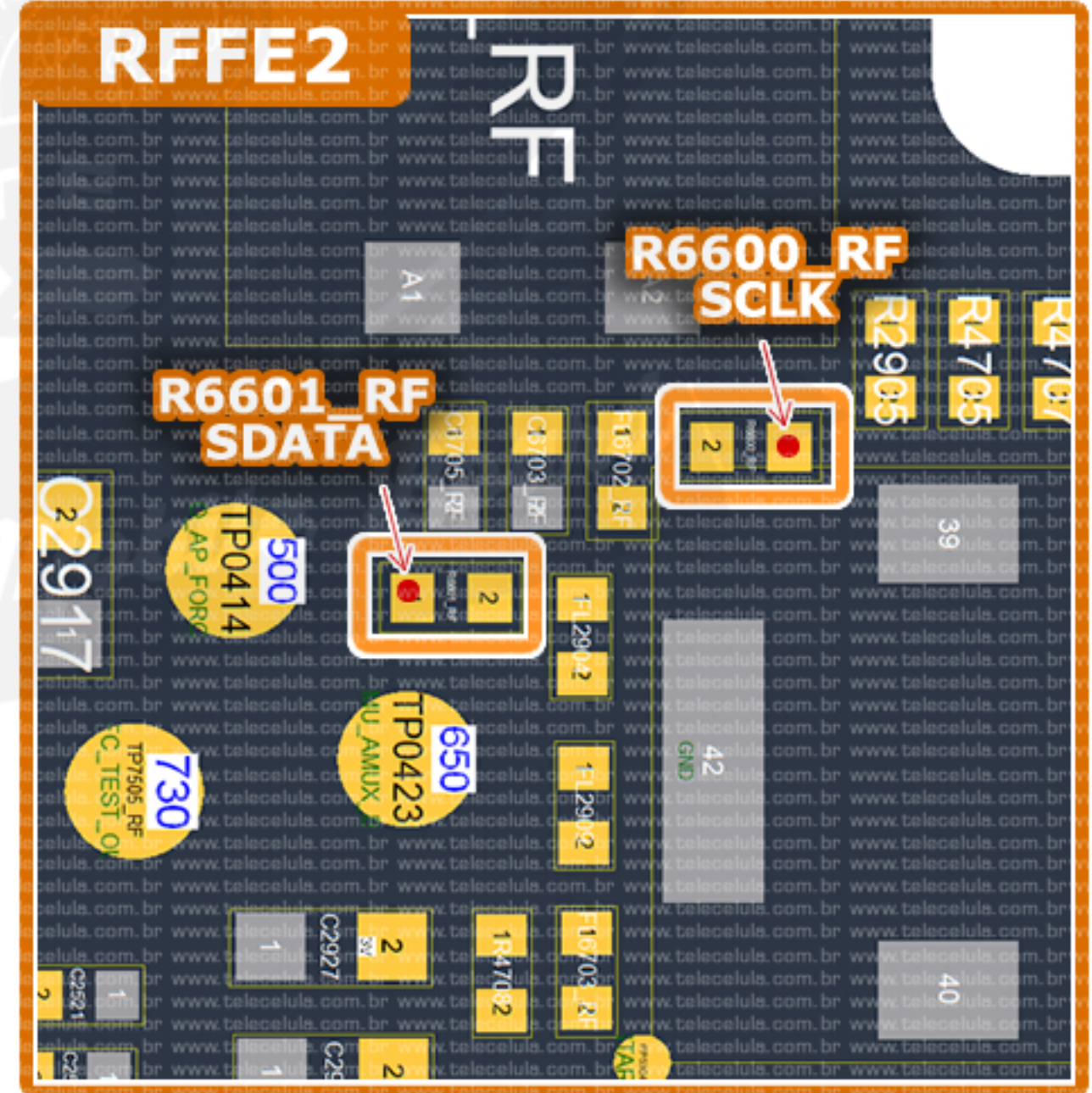
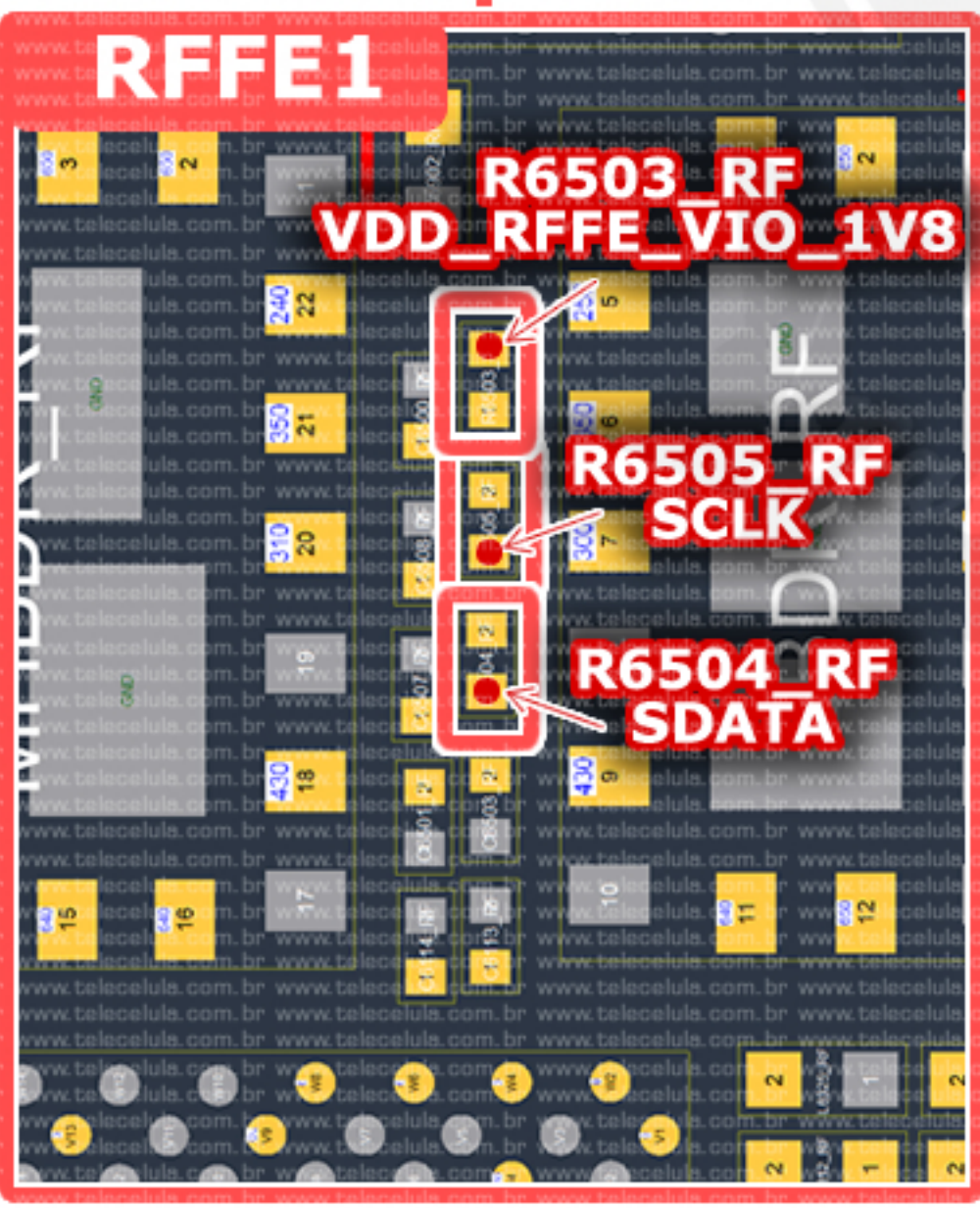
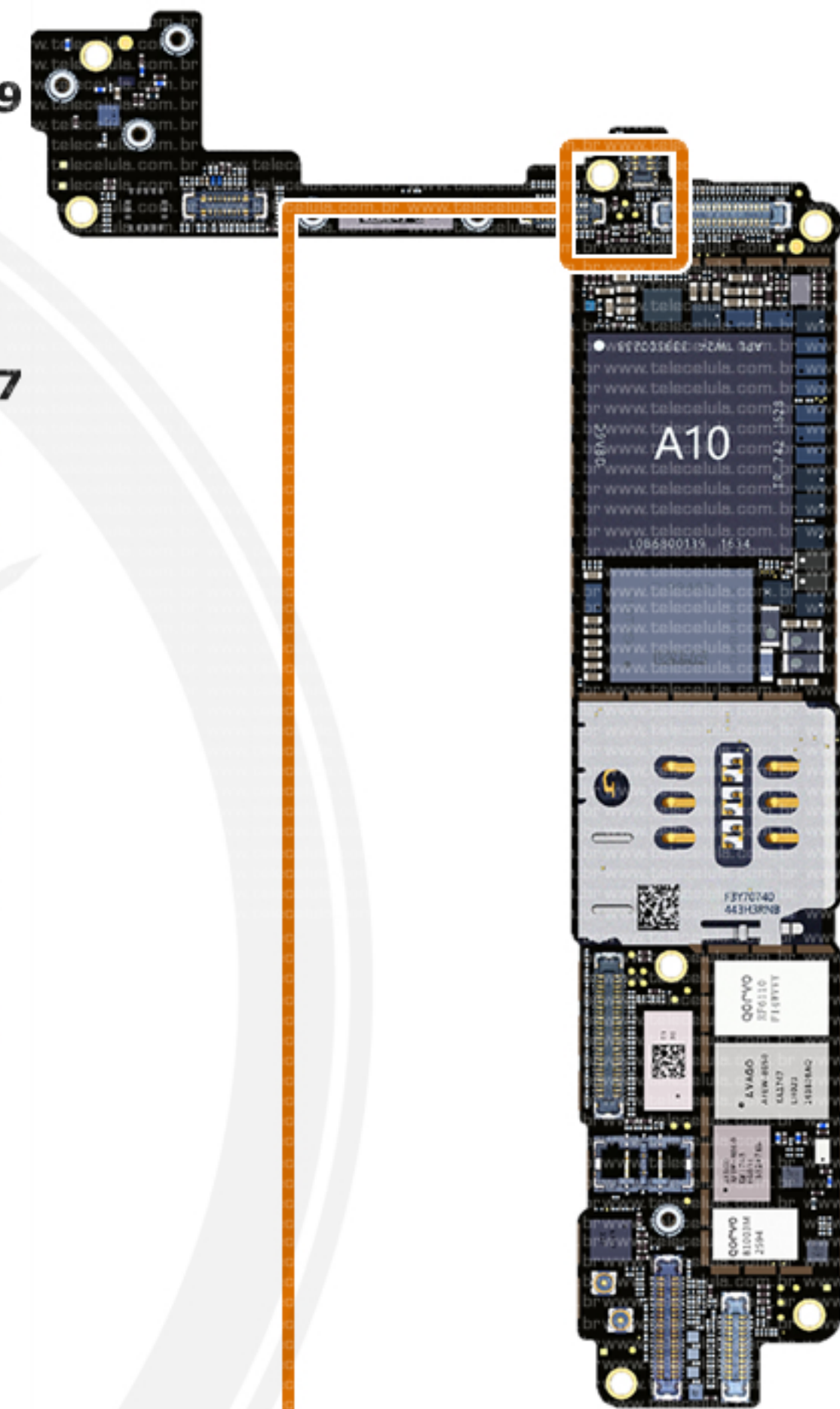

RFFE <-> (BB_RF)

IPHONE 7 QUALCOMM

APN: 820-00188-A

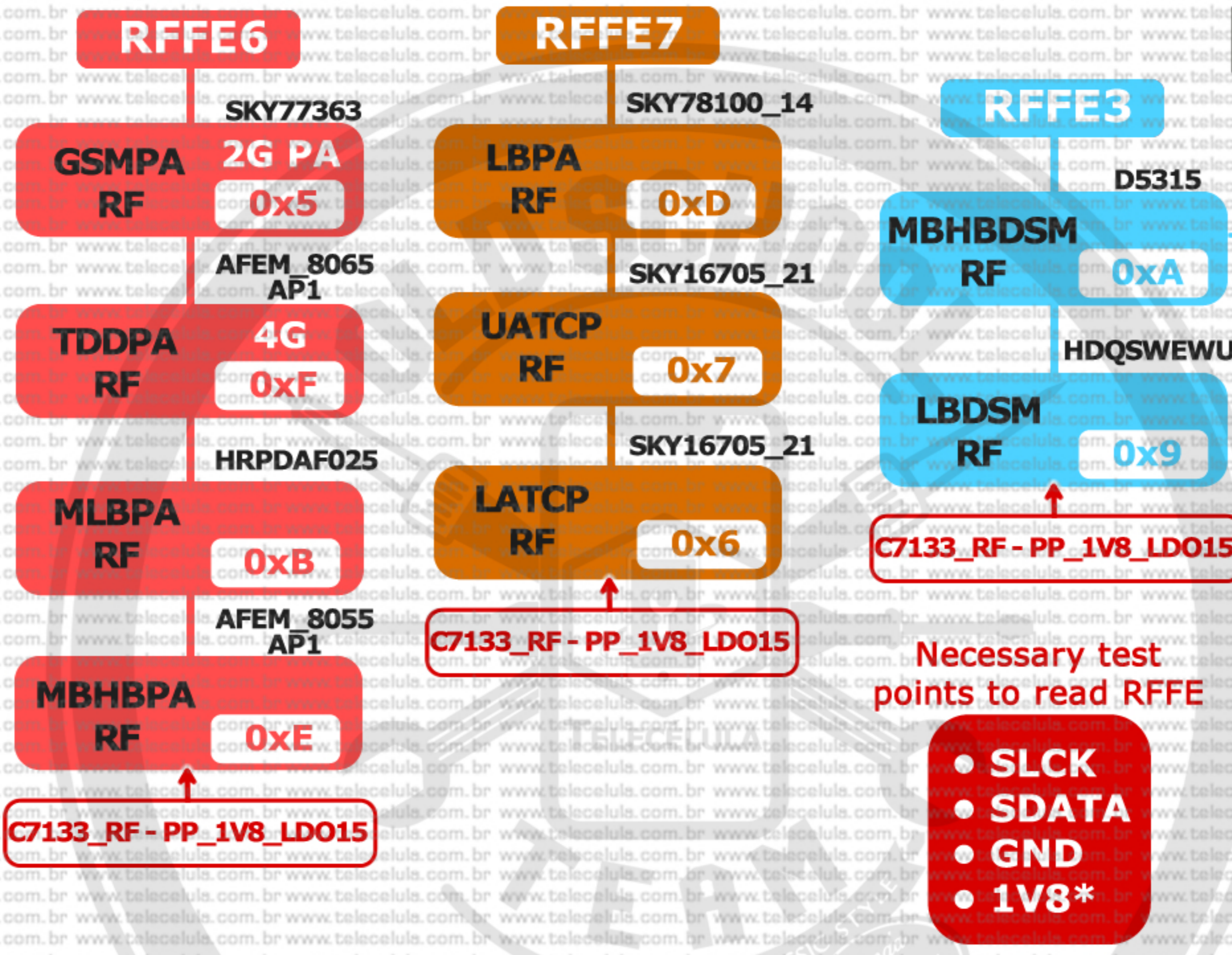
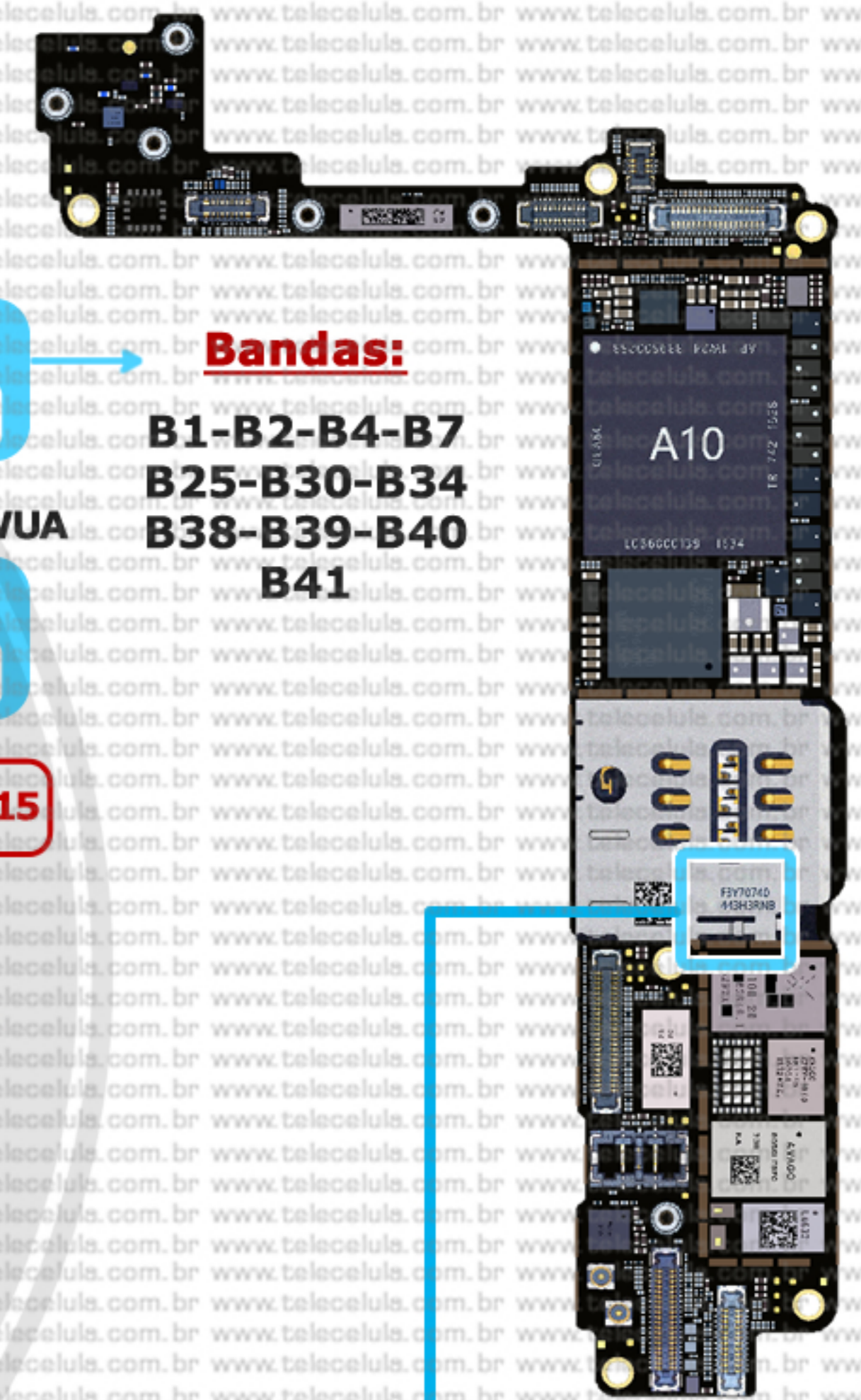
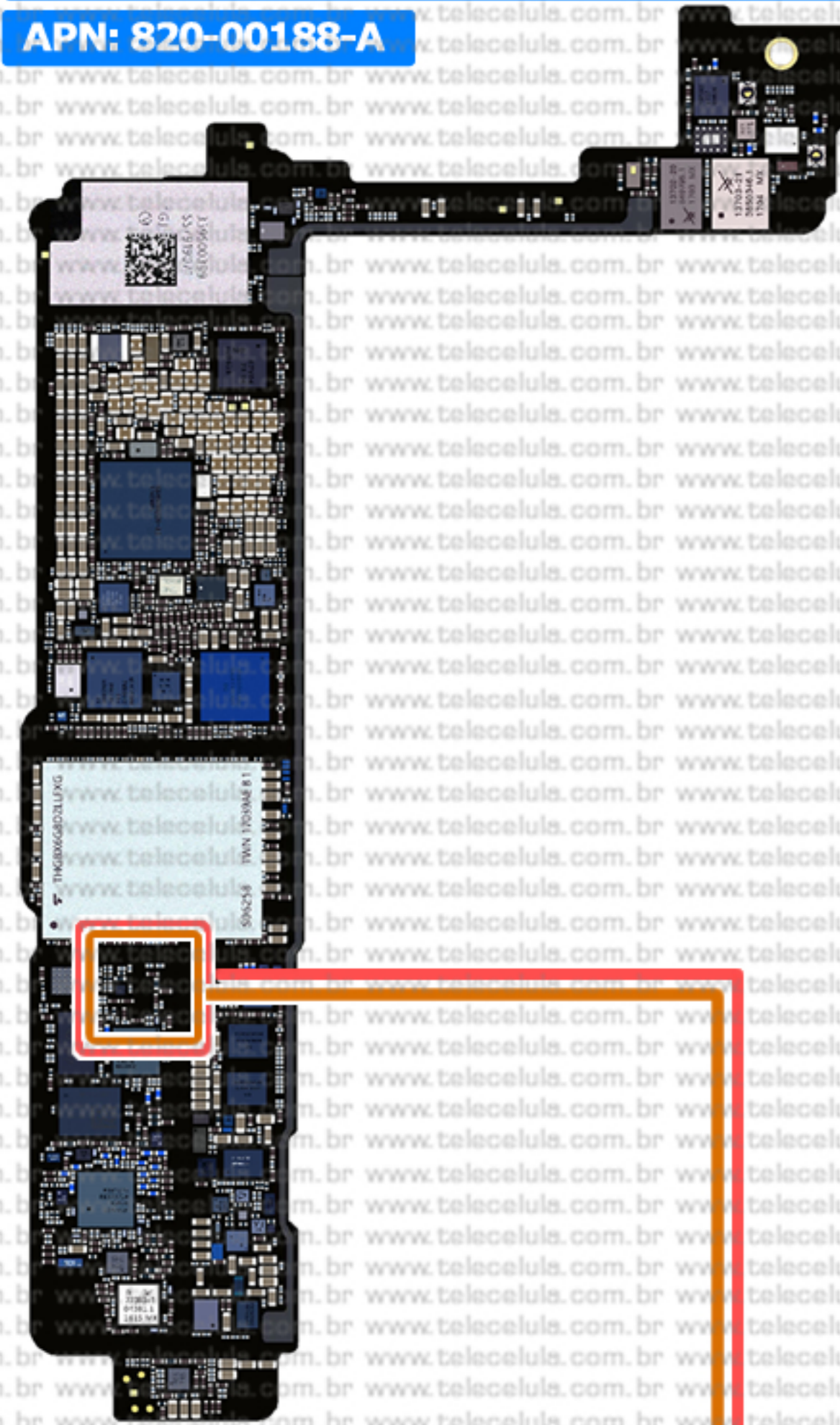

Bandas:

- B1-B2-B4-B7
- B25-B30-B34
- B38-B39-B40
- B41

Necessary test points to read RFFE

- SCLK
- SDATA
- GND
- 1V8*

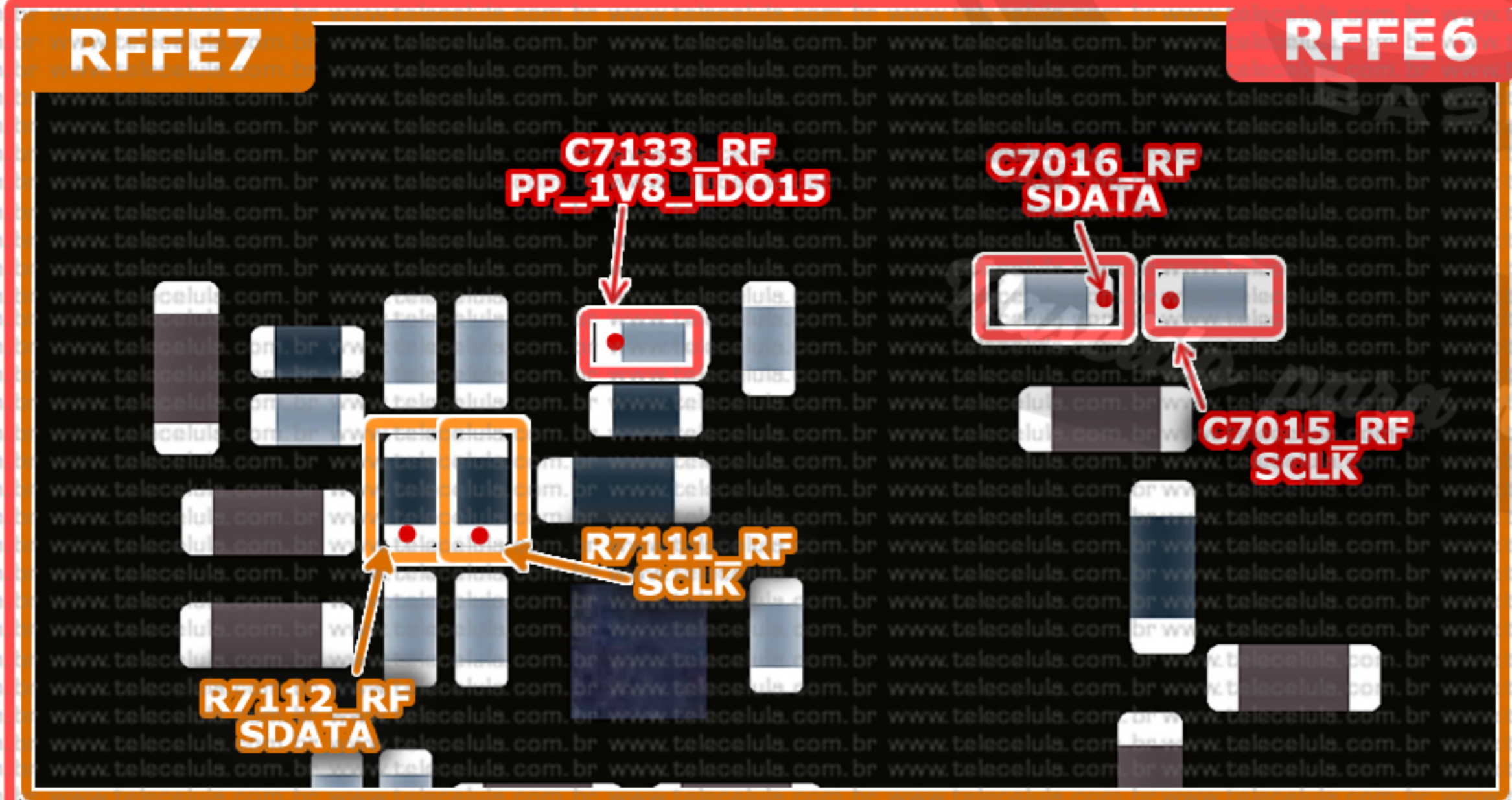

RFFE TABLE

RFFE1:	WTR 3925
RFFE2:	QFE 3100
RFFE3:	DIU MODULES
RFFE4:	WTR 4905
RFFE5:	TUNERS + ELNAS
RFFE6:	2GPA, MLB PA, MB/HB TDD PA, MB/HB FDD PA
RFFE7:	LB PA, COUPLERS

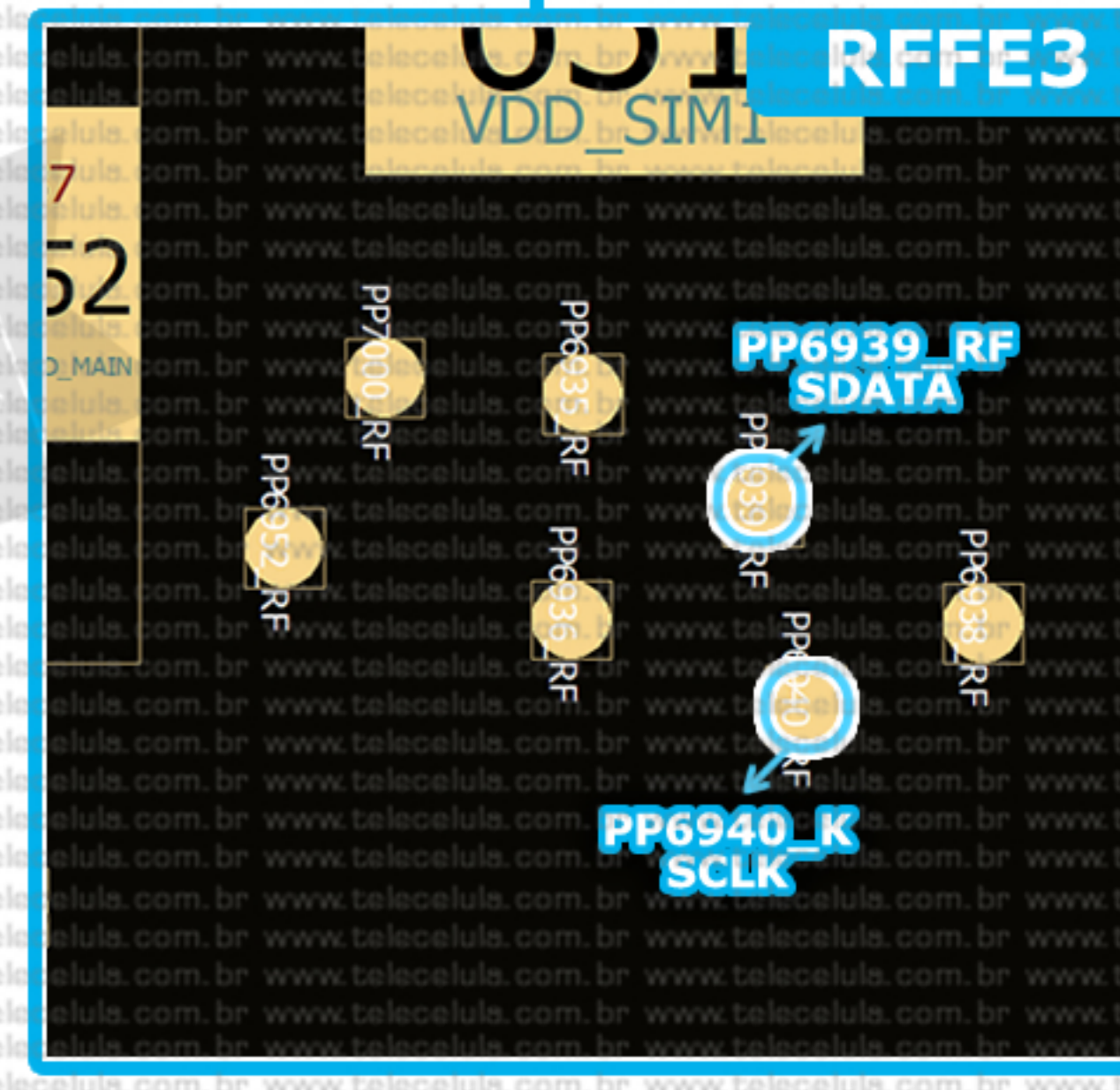

RFFE - (XCVRO_K)

(XCVR1_K)

IPHONE 8 INTEL

APN: 820-00872-A

RFFE1

SKY77367

GSM PA_K 2G PA
0x5

MB_HB_TDD
S_PAD

TDD PA_K 4G
0xF

QM 81004M

ET_K 0xC

AFEM_8056
AP1

FL600_K
PP1V8_S2

MBHB PA_K
0xE

QM 76041

LB PA_K 0xD

SKY16708_11

UAT CP_K 0x7

SKY16708_11

LAT CP_K 0x6

DRX_DS M

0x9 0xA

LB_MB_HB_DRX_A SM

QM18099

LAT TUNER

* GPO 0x8

PP1V8_S2 - FL600_K

J6400

DOCK

FLEX

C801_K / R800_K
R1200_K
VDD_RFFE_VIO_1V8_K



RFFE2

FL301_KF
PP1V8_S2

R302

R302_KF
SDATA

R304_KF
SCLK

RFFE2

SKY13764_14

MB/HB
DRX_LNA 0x3

VDD_RFFE_VIO_1V8_K
R800_K

SKY13767_11

LBLN_K 0x2

VDD_RFFE_VIO_1V8_K
R800_K

UAT_TUNER_FLEX
TUNFX_KF

* PP1V8_S2 - FL301_K

QM18098

UAT TUNER GPO

* 0x8

PP1V8_S2 - FL301_K

- SLCK
- SDATA
- GND
- 1V8*

Necessary test points to read RFFE



RFFE - BB (MDM)

Necessary test points to read RFFE

IPHONE 8 QUALCOMM

APN: 820-00871-A

TOP BOTTOM

- SLCK
- SDATA
- GND
- 1V8*

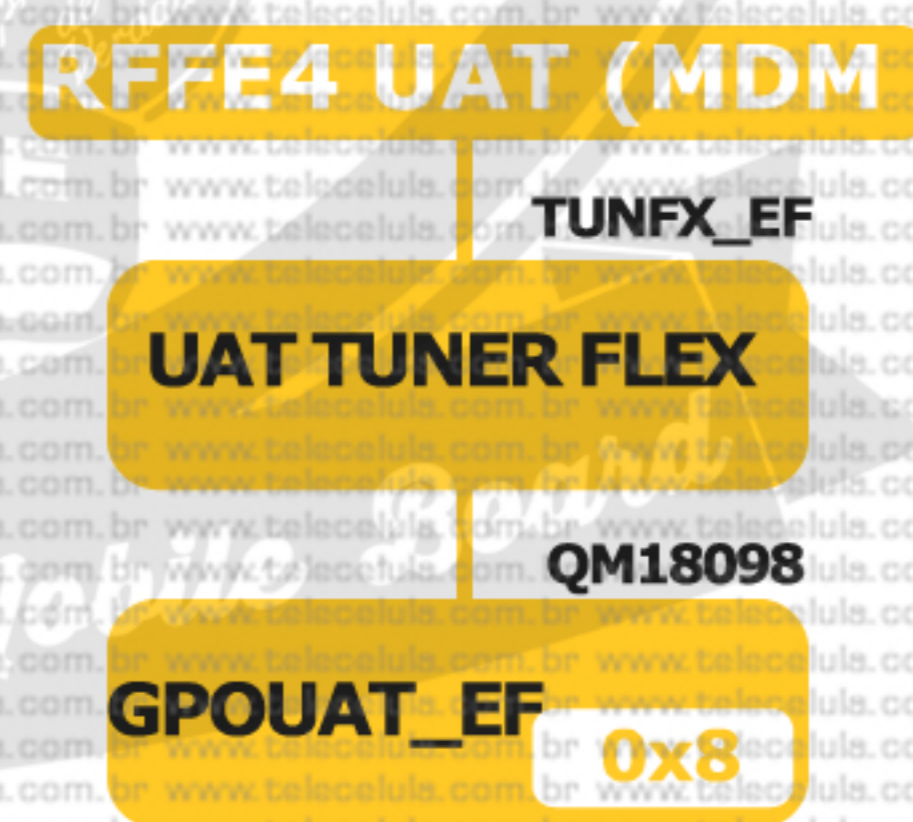
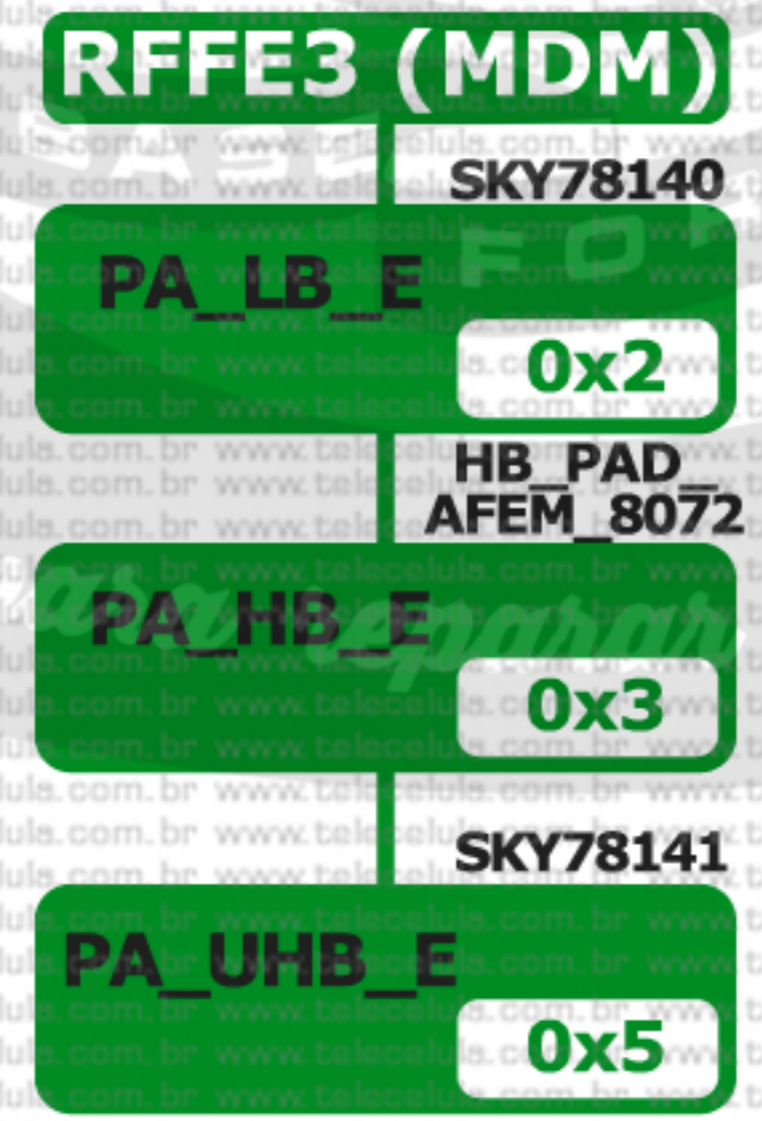
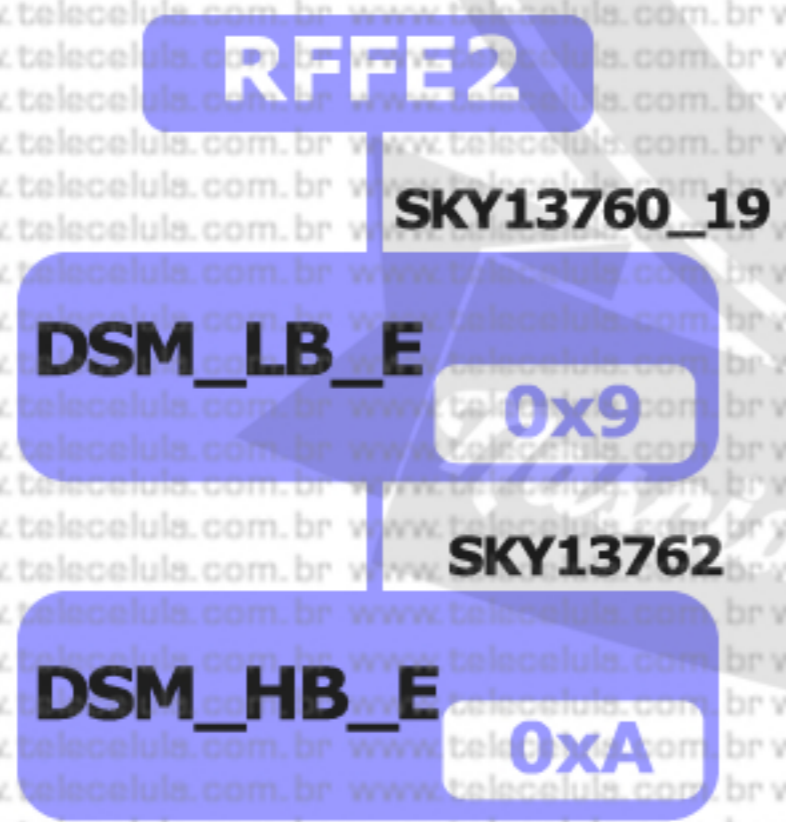
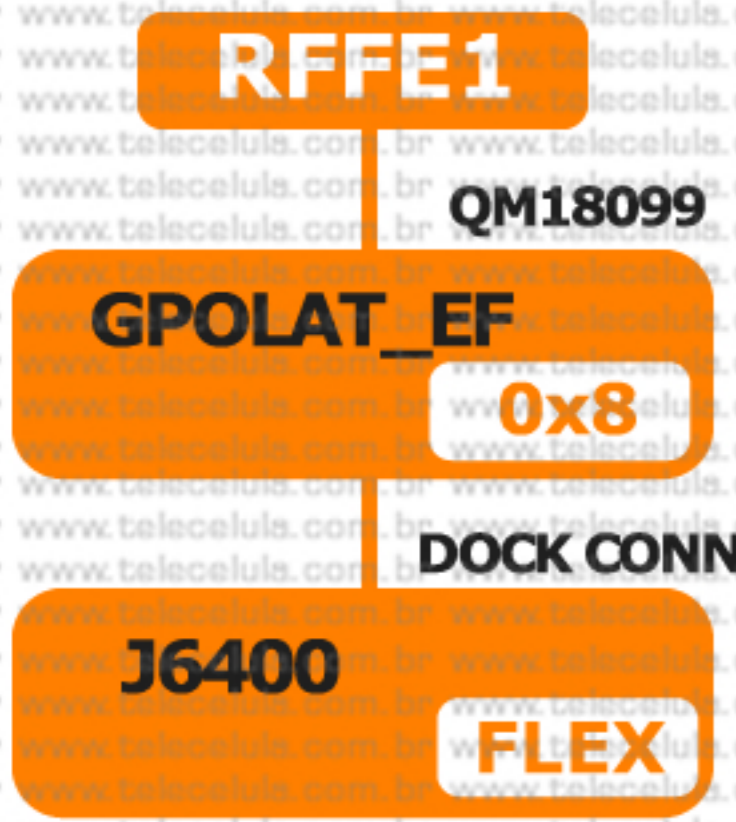
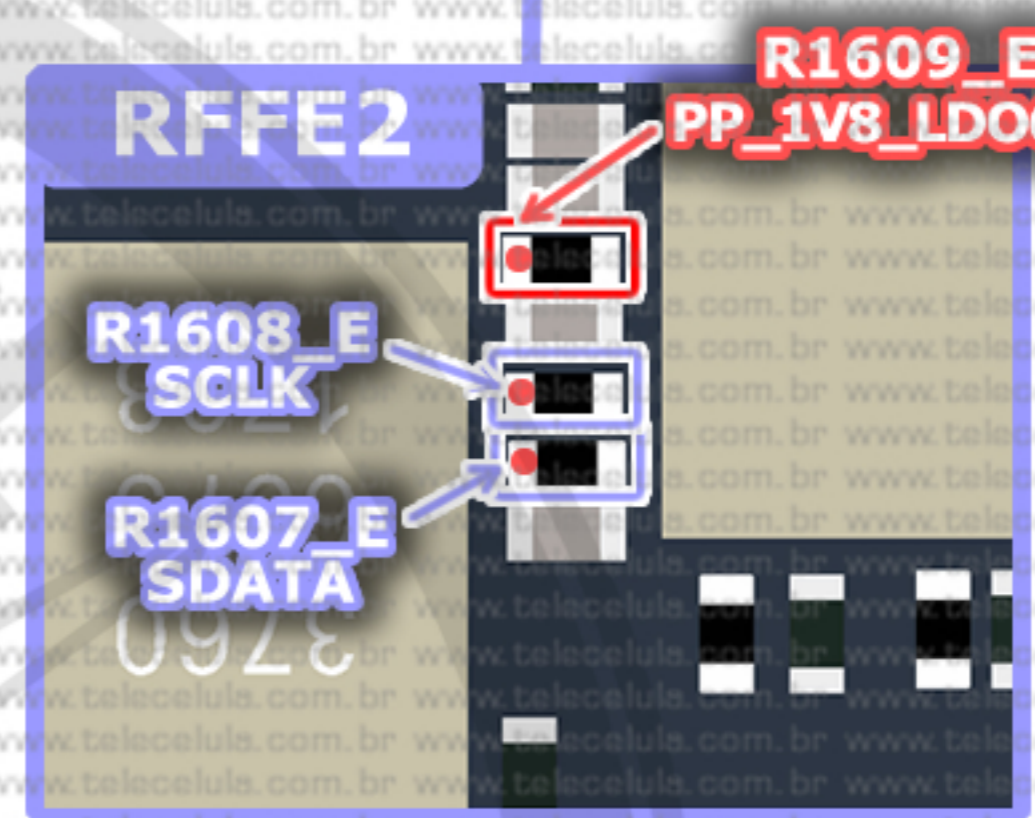
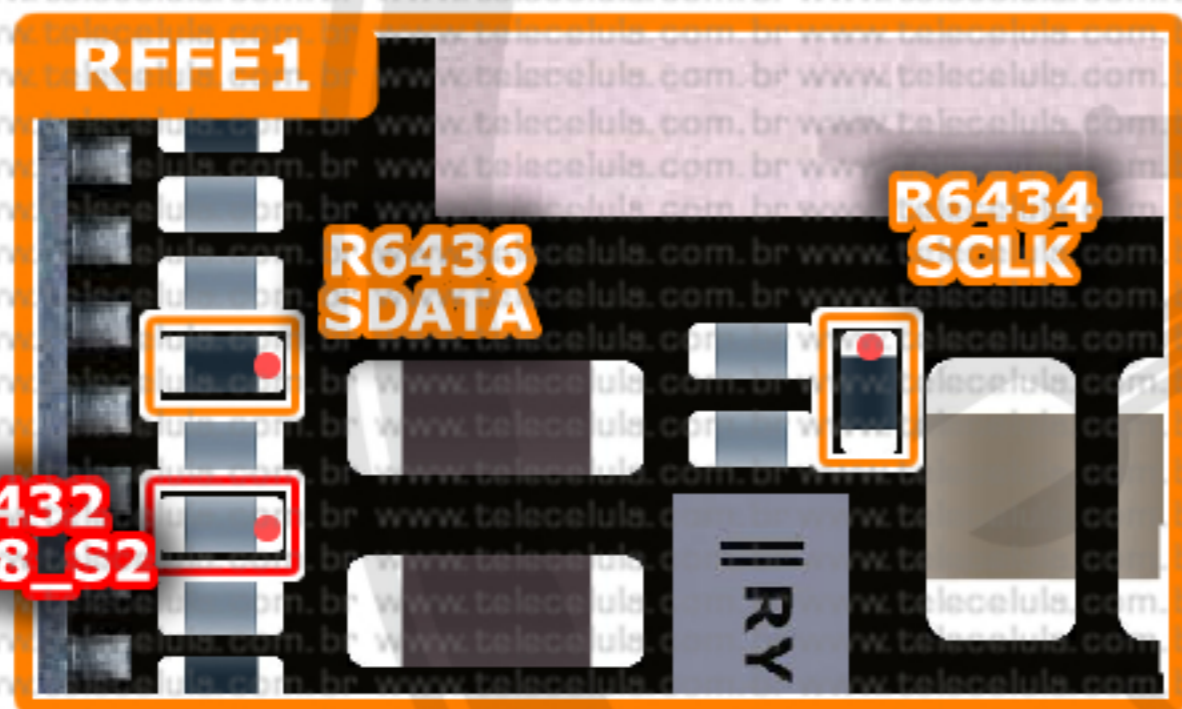
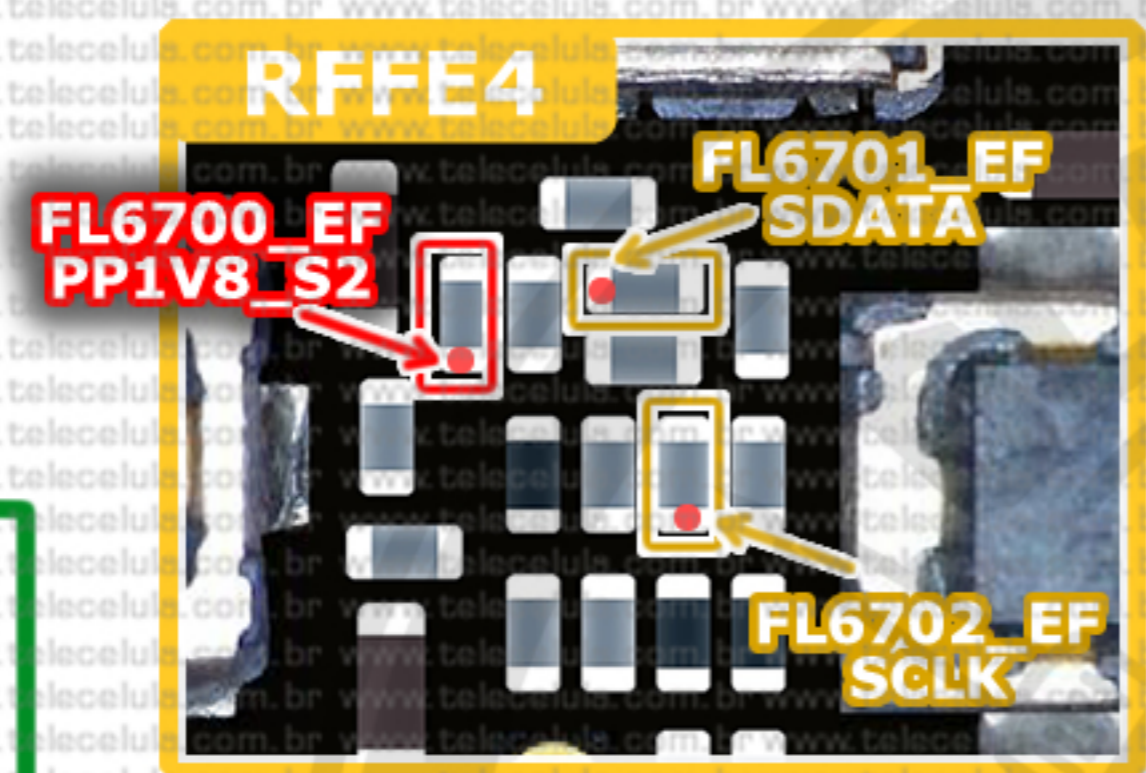
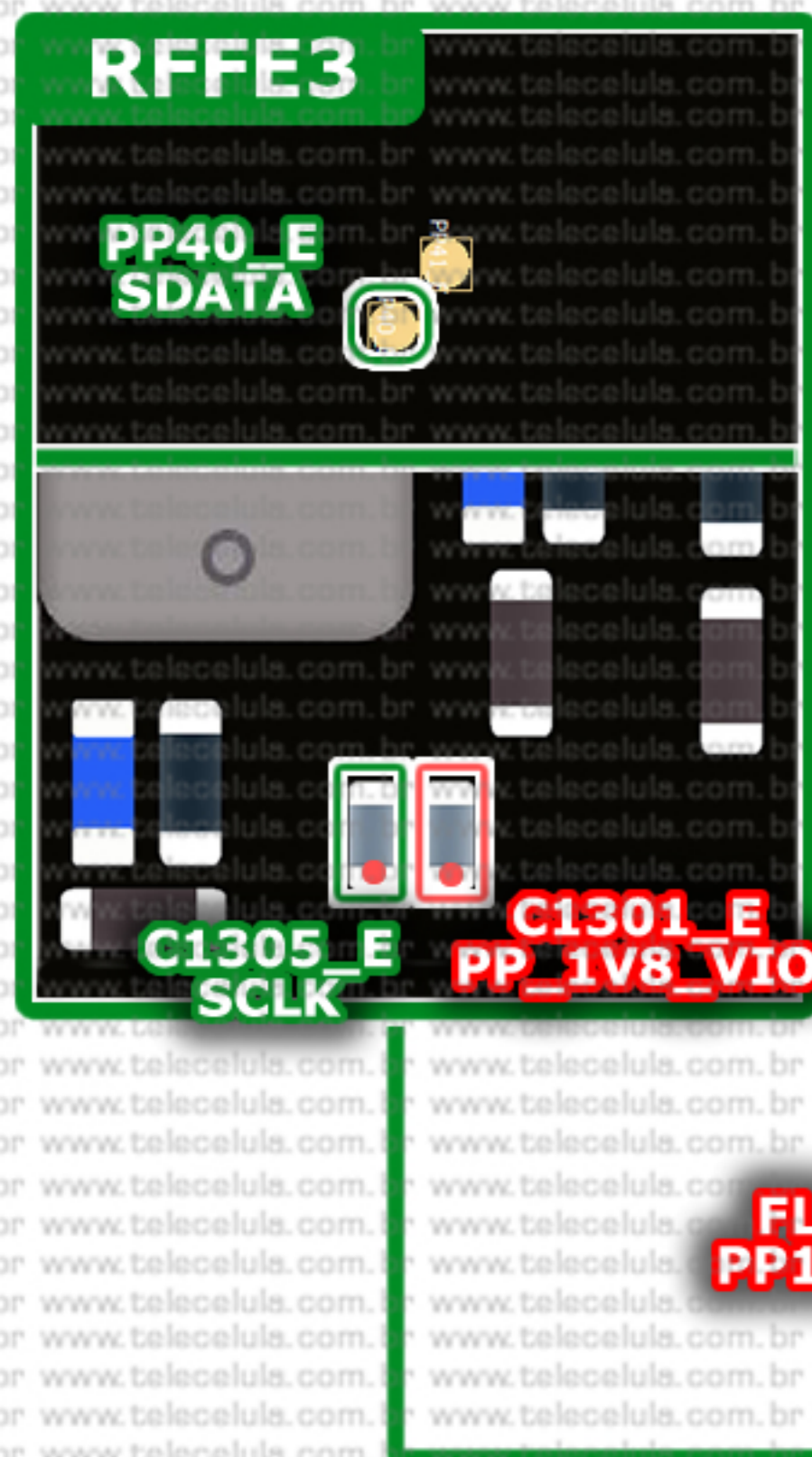

FL6432
FL6902 EF
PP1V8_S2

R1609_E
PP_1V8_LDO6_E

R1301_E
PP_1V8_VIO = PP_1V8_LDO6_E

FL6700_EF
PP1V8_S2

C1110_E
PP_1V8_LDO6_E

IPHONE X INTEL

APN: 820-0863-12

RFFE - (XCVR0_K) (XCVR1_K)

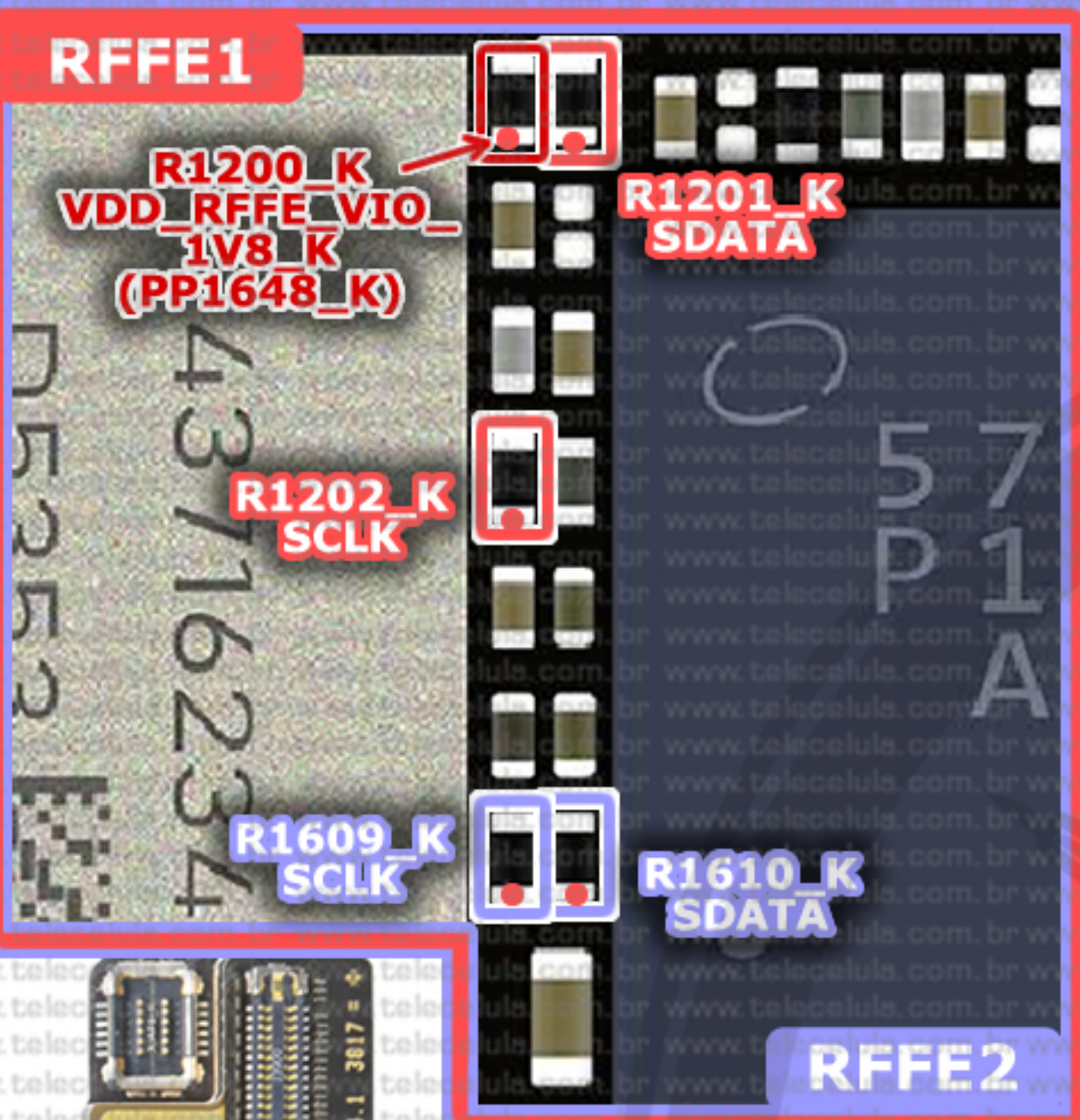

RFFE1	SKY77367
GSM PA_K	2G 0x5
TDD PA_K	4G 0xF
ET_K	QM81004M 0xC
MB/HB PA_K	AFEM_8056_AP1 0xE
LB PA_K	QM76041 0xD
UATCP_K	SKY16708_11 0x7
LATCP_K	SKY16708_11 0x6
GPOLAT_K	0x8
DRX DSM	DSM_K DRX DSM B30608_M5342_X969 0x9 0xA

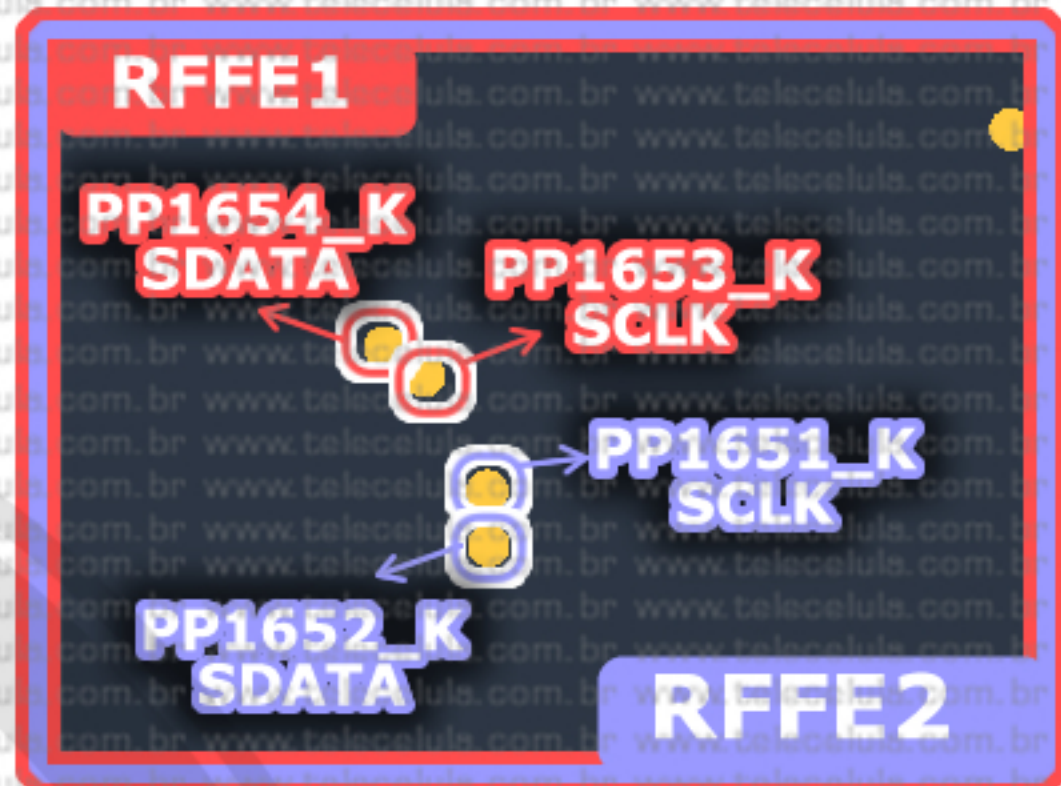

RFFE2	SKY13764_14
MB/HB DRX LNA	0x3 VDD_RFFE_VIO_1V8_K PP1648_K
LB DRX LNA	SKY13767_11 0x2 VDD_RFFE_VIO_1V8_K PP1648_K
GPOUAT_K	QM18098 0x8 UAT PP1V8_S2 - J_DEBUG_K PAD 9

Necessary test points to read RFFE

- SCLK
- SDATA
- GND
- 1V8*

VDD_RFFE_VIO_1V8_K - PP1648_K

PP1648_K VDD_RFFE_VIO_1V8_K

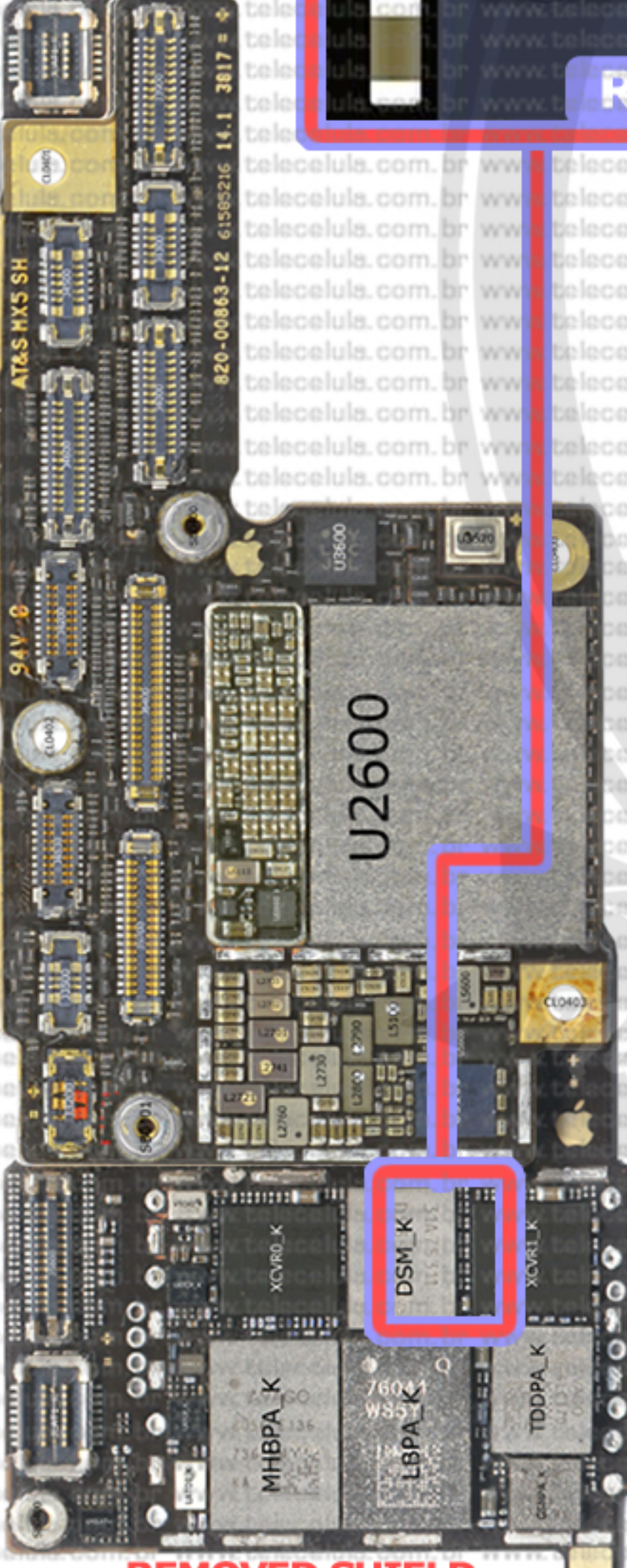
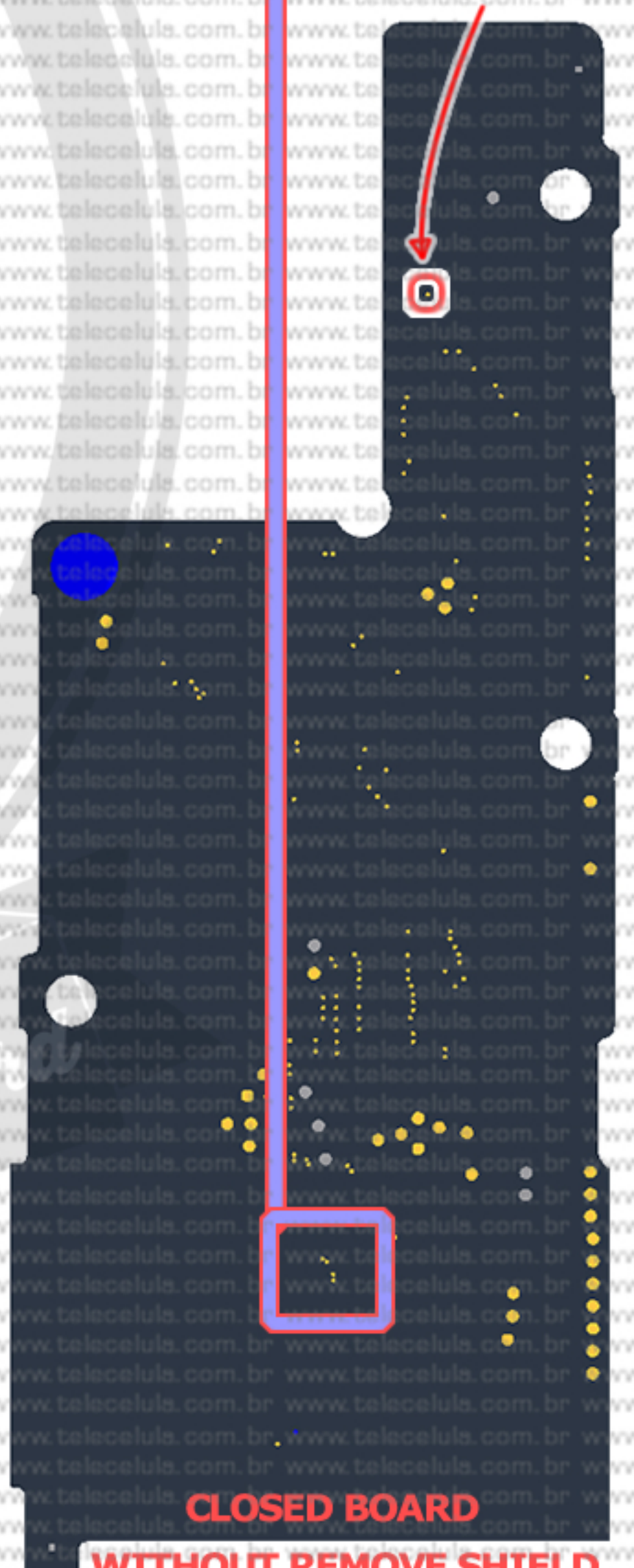

IPHONE X QUALCOMM

APN: 820-0864-A

RFFE - (XCVRO_K) - MDM

(XCVR1_K) - MDM

RFFE MAP

RFFE1: WTR, LATGPO, LATUNE
RFFE2: HB DSM, LB DSM
RFFE3: UHB, HB, LB PAD LNA
RFFE4: UATGPO, UATUNE
RFFE5: CPL
RFFE6: QET, 2G PA/UHB, HB, LA PAD

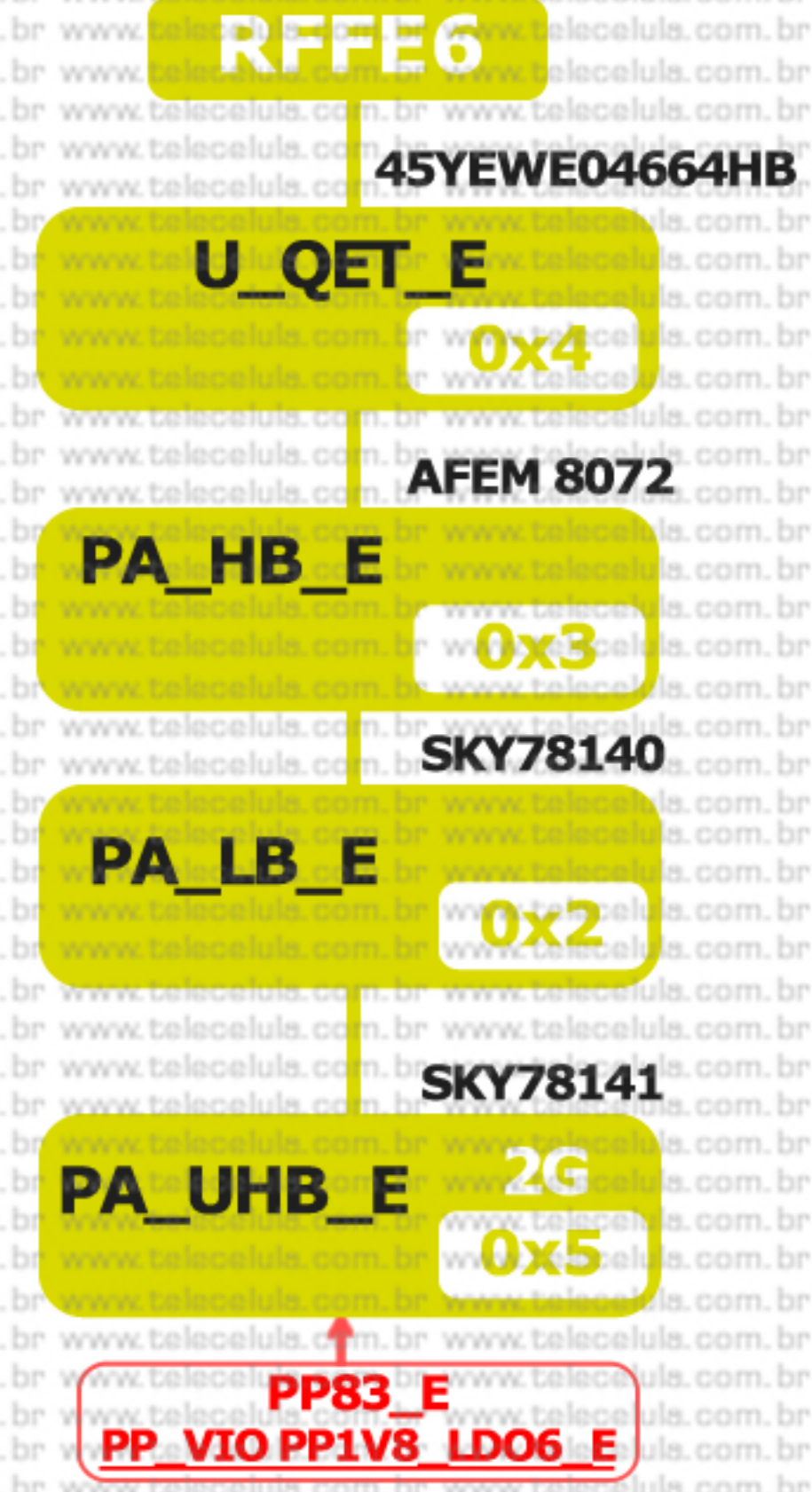
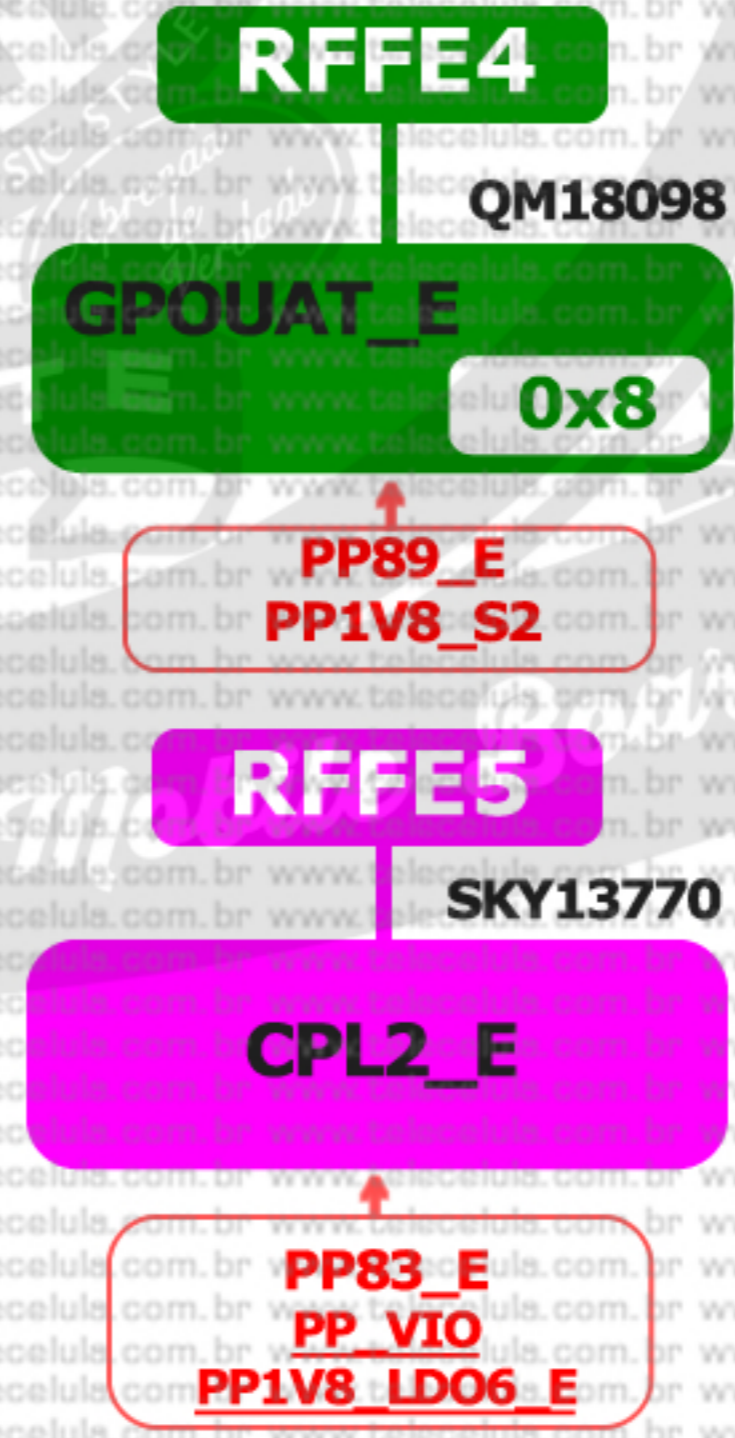
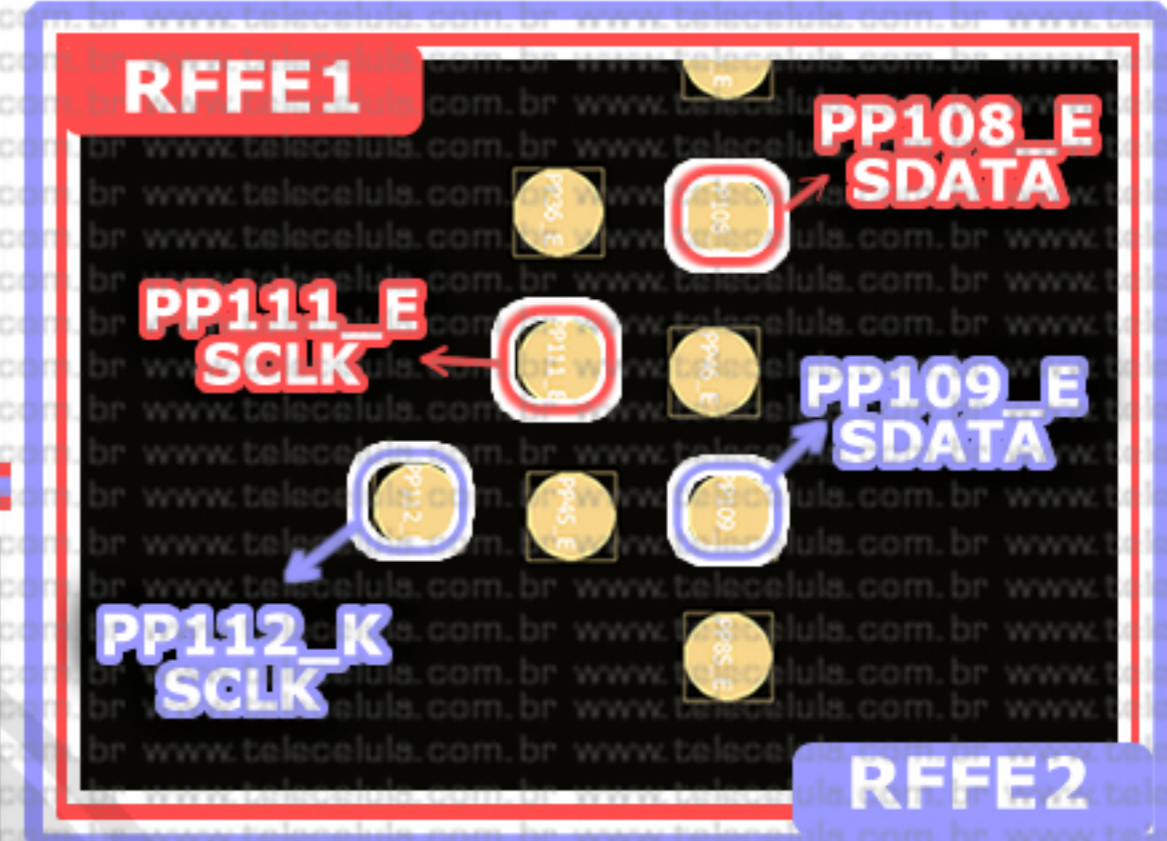
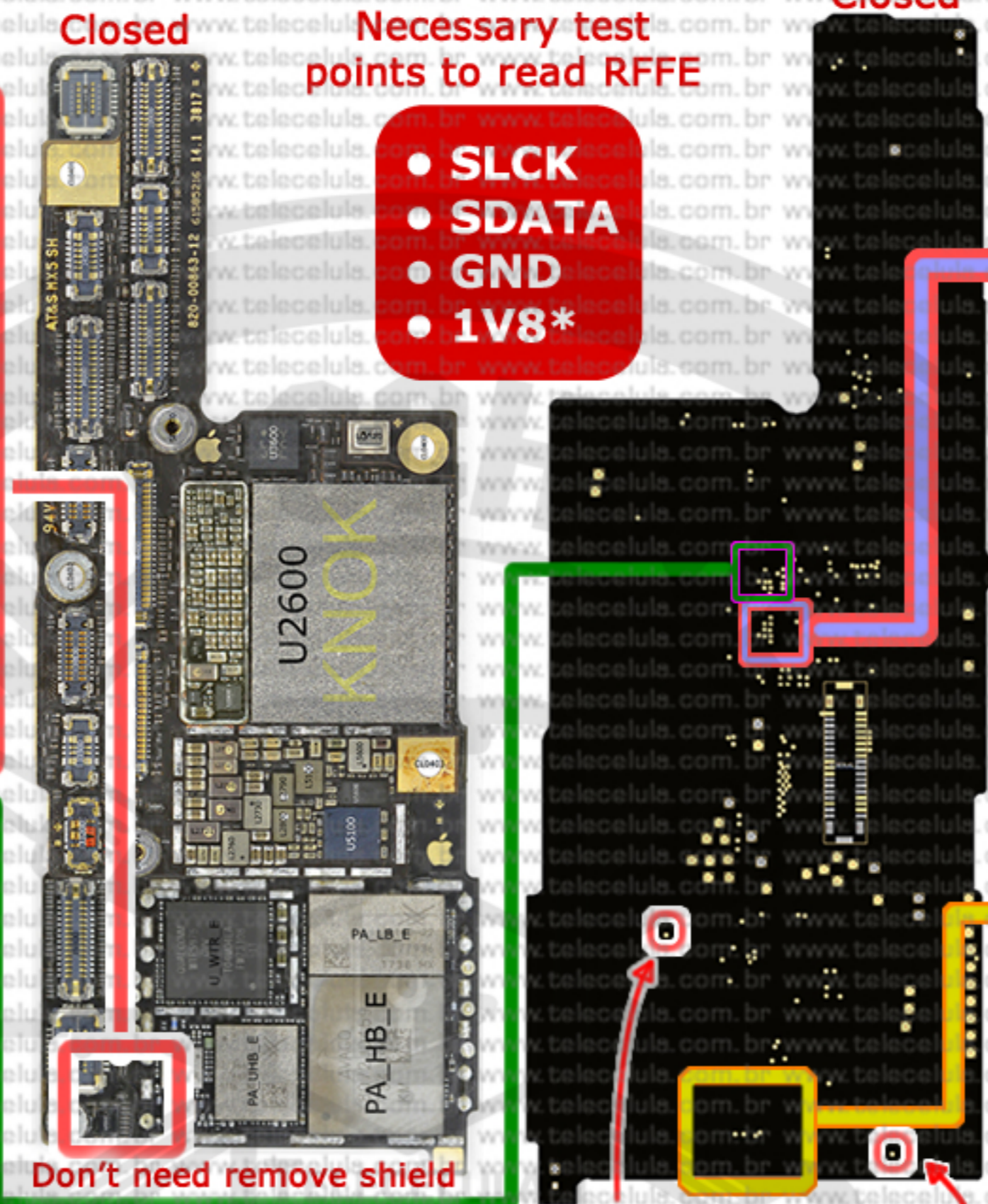
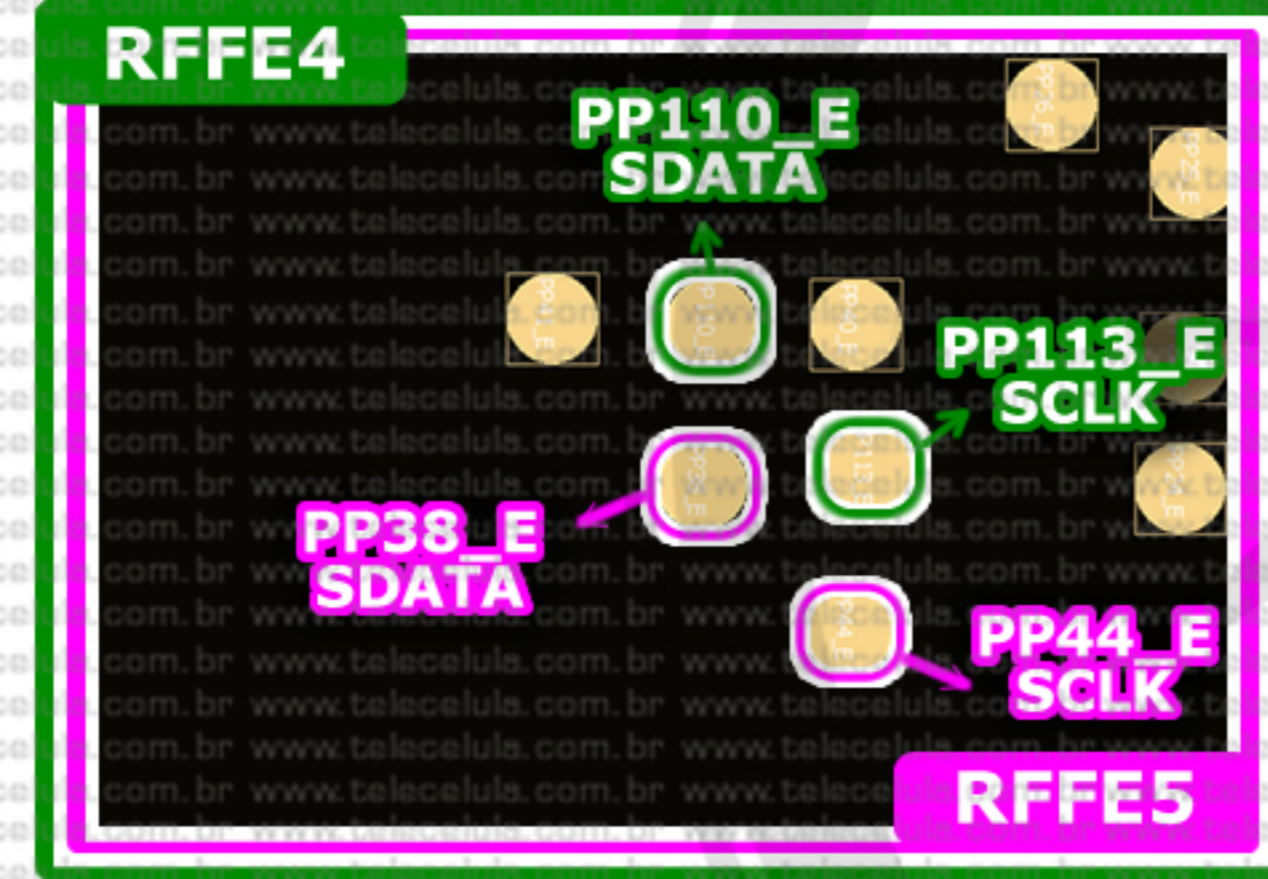
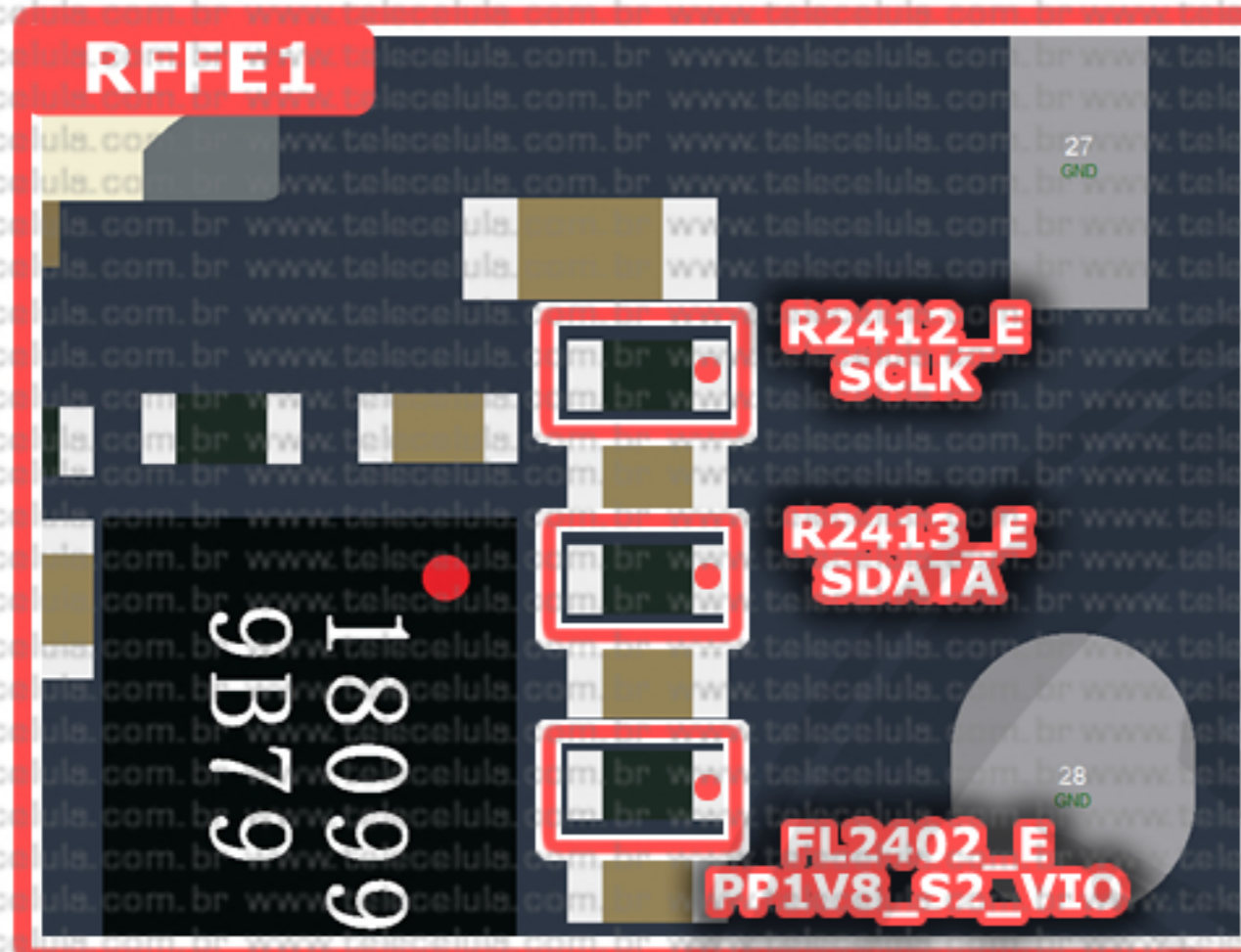

RFFE - XCVR (U_XCVR_K)

IPHONE XR

APN: 820-01209-A

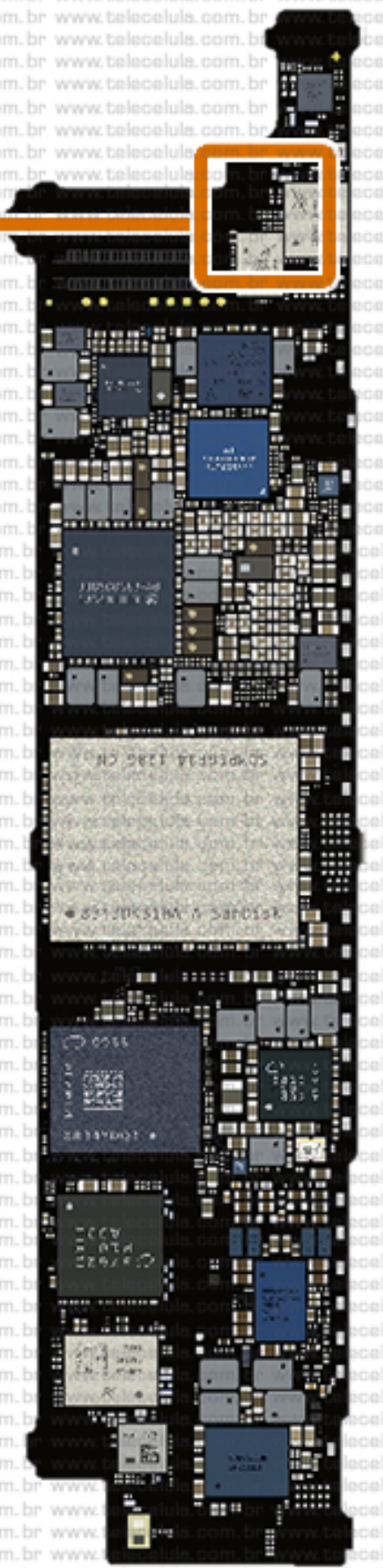

RFFE2

RFFE3

U_XCVR_K (TX)

XCVR_TO_FE_RX_RFFE

QM76018

SKY13768

PA_HB_K

DSM_HB_K

0x3

0xA

HRPDAF092

SKY13765

PA_UHB_K

DSM_LB_K

0x5

0x9

SKY78170

HRPDAF092

PA_LB_K

PA_UHB_K

2G

0x2

0xC

QM81019

QM76018

U_ET2_K

PA_HB_K

0xC

0xE

HFQFEGVGB

SKY78170

CPL_K

PA_LB_K

0x6

2G

0xD

PP_1V8_VIO_TX

PP1V8_LBDSM_RFFE_IO_FILT

RFFE2

RFFE3

Necessary test points to read RFFE

- SLCK
- SDATA
- GND
- 1V8*

C1405_K
SCLK

C1406_K
SDATA

C1404_K
PP_1V8_VIO_TX

R1708_K
SCLK

R1707_K
SDATA

R1704_K
PP1V8_LBDSM_RFFE_IO_FILT

PP1V8_LBDSM_RFFE_IO_FILT

PP_1V8_VIO_TX

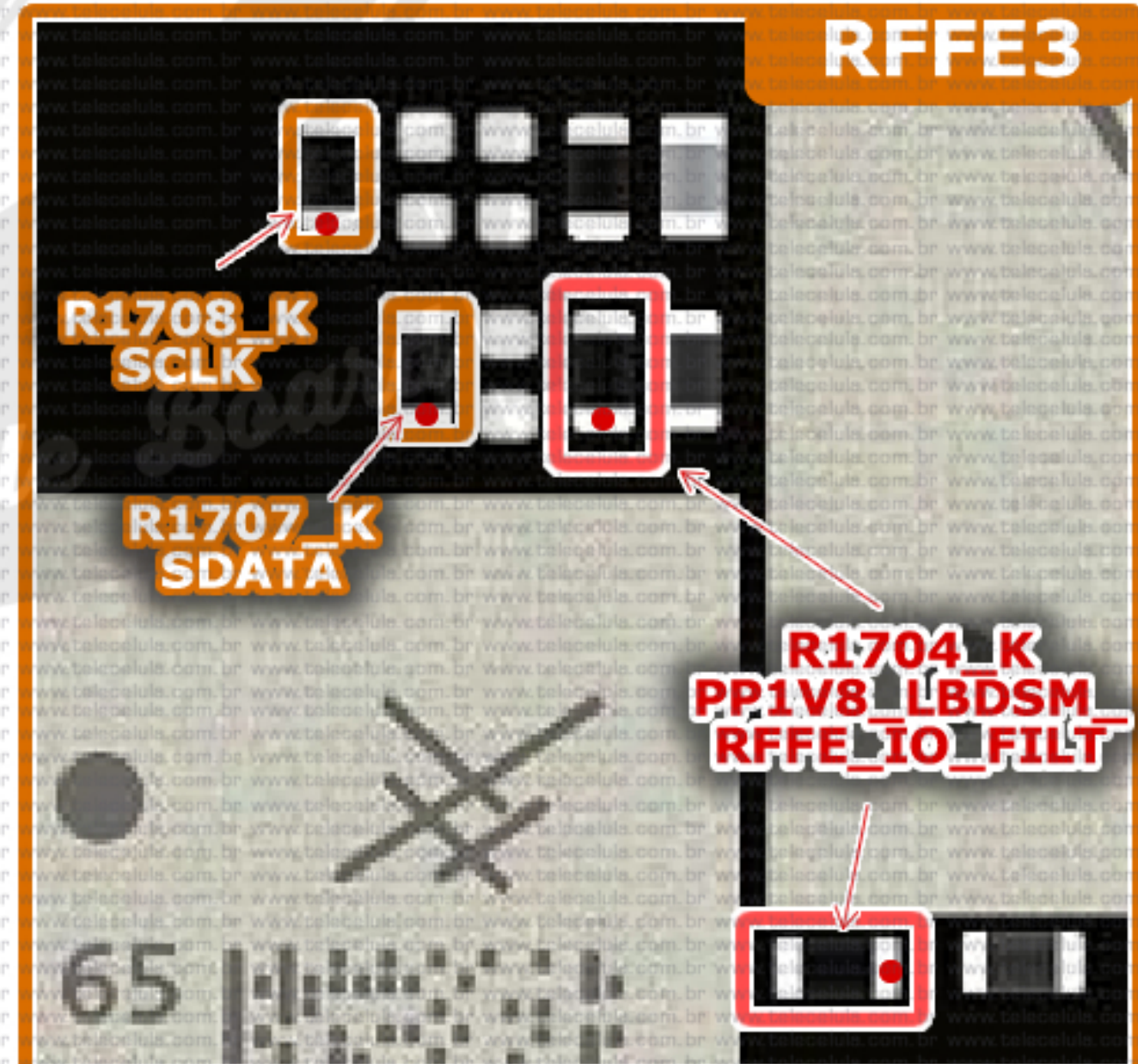

RFFE -XCVR

IPHONE XS

APN: 820-0997-A

R1905_K
PP_1V8_XCVR_TO_FE_RFFE_IO

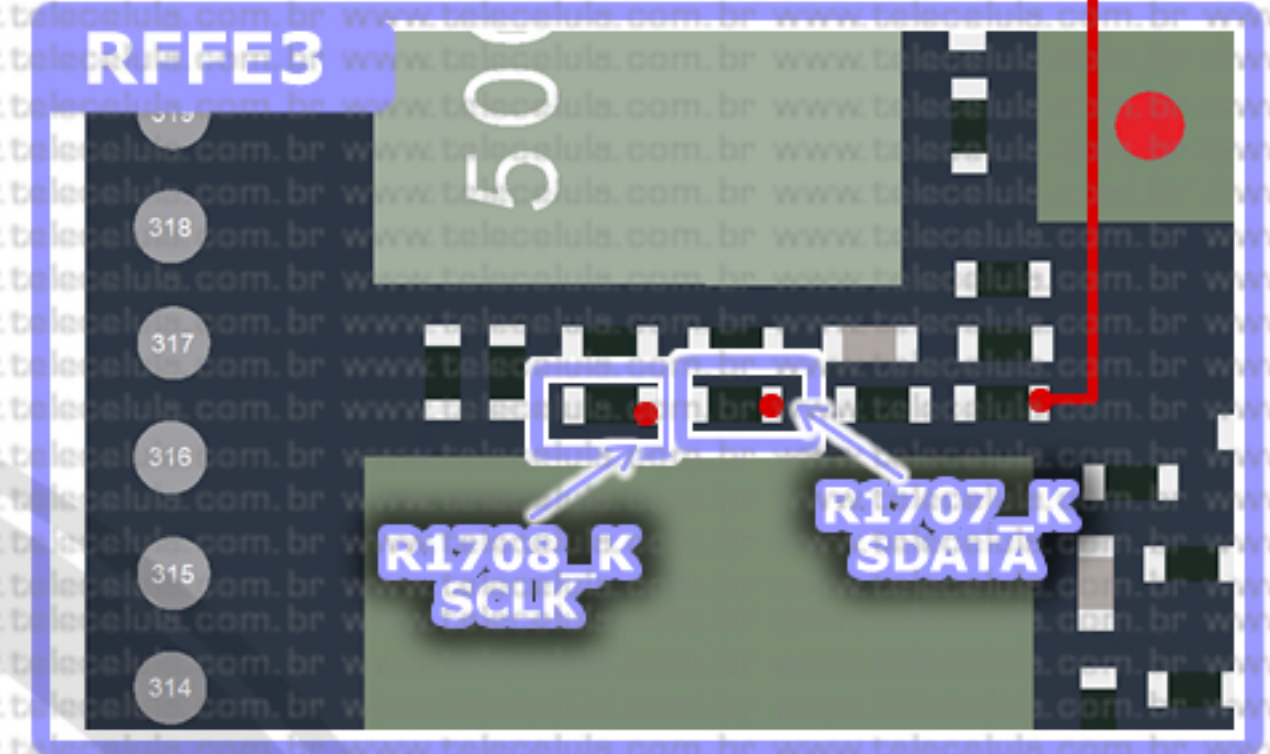
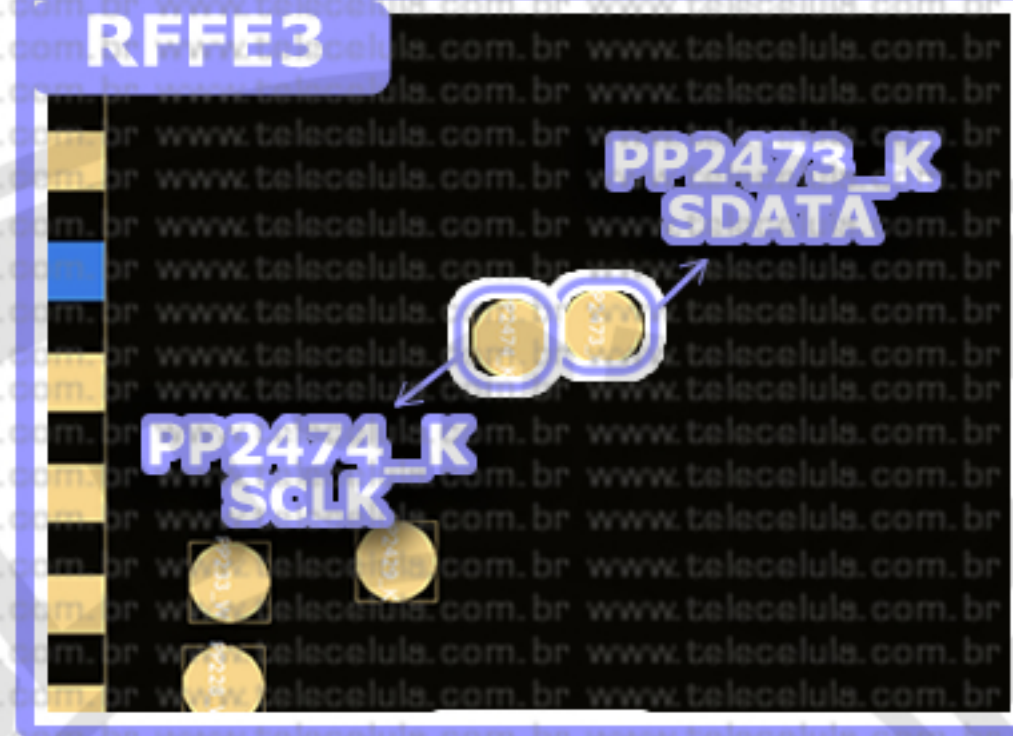
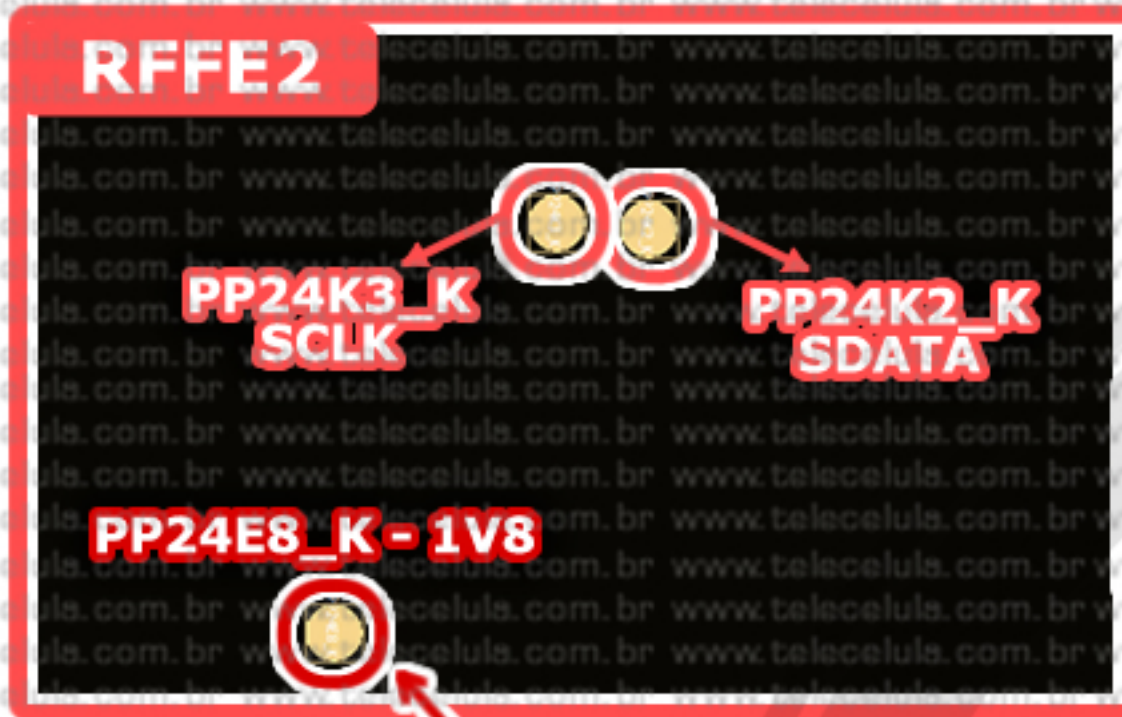

PP_1V8_XCVR_TO_FE
RFFE_IO

CLOSED BOARD

BOARD OPEN

RFFE2/XCVR

XCVR TO FE RX RFFE 3



- SLCK
- SDATA
- GND
- 1V8

Necessary test points to read RFFE

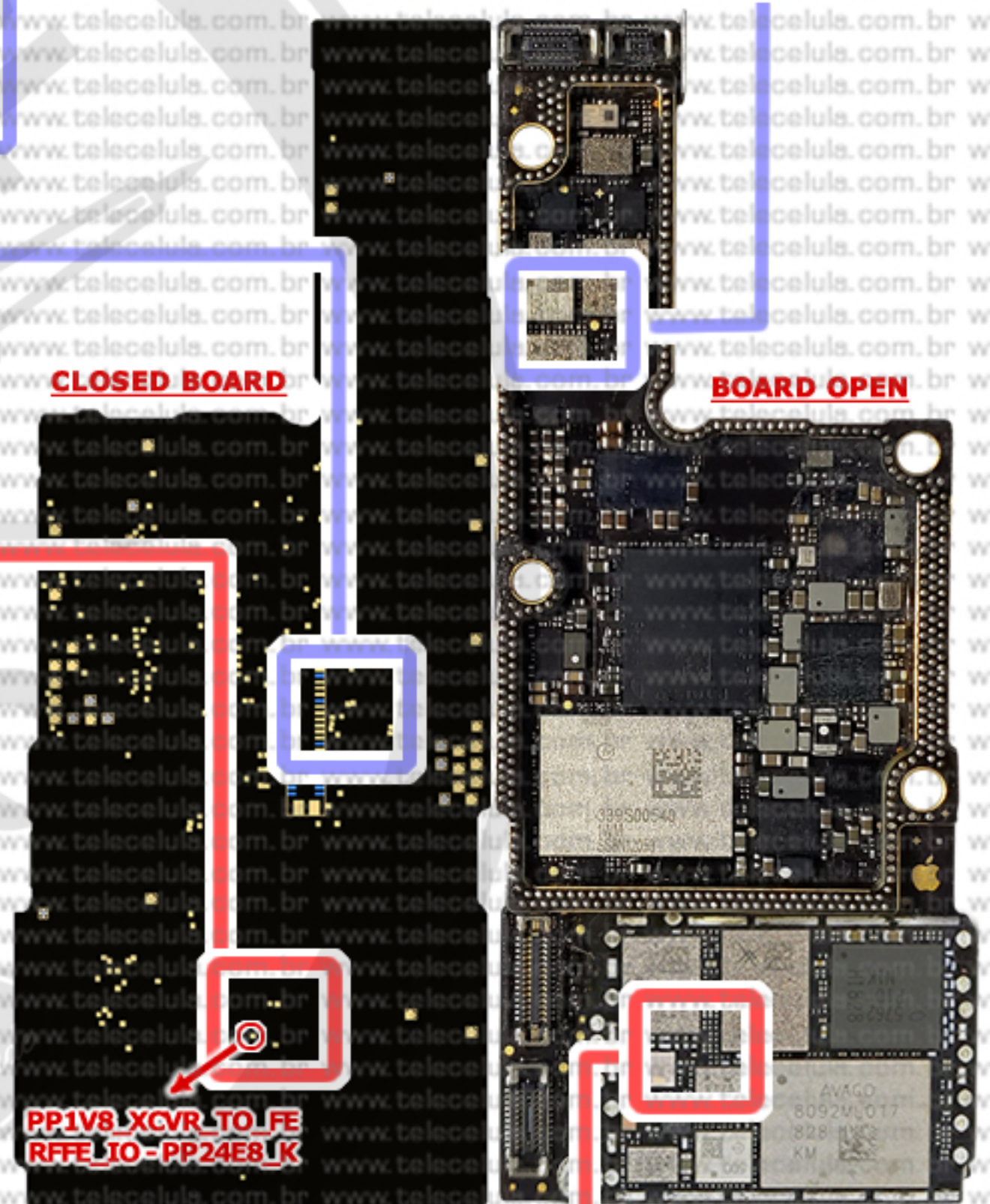

RFFE

IPHONE XS MAX

APN: 820-001063-A

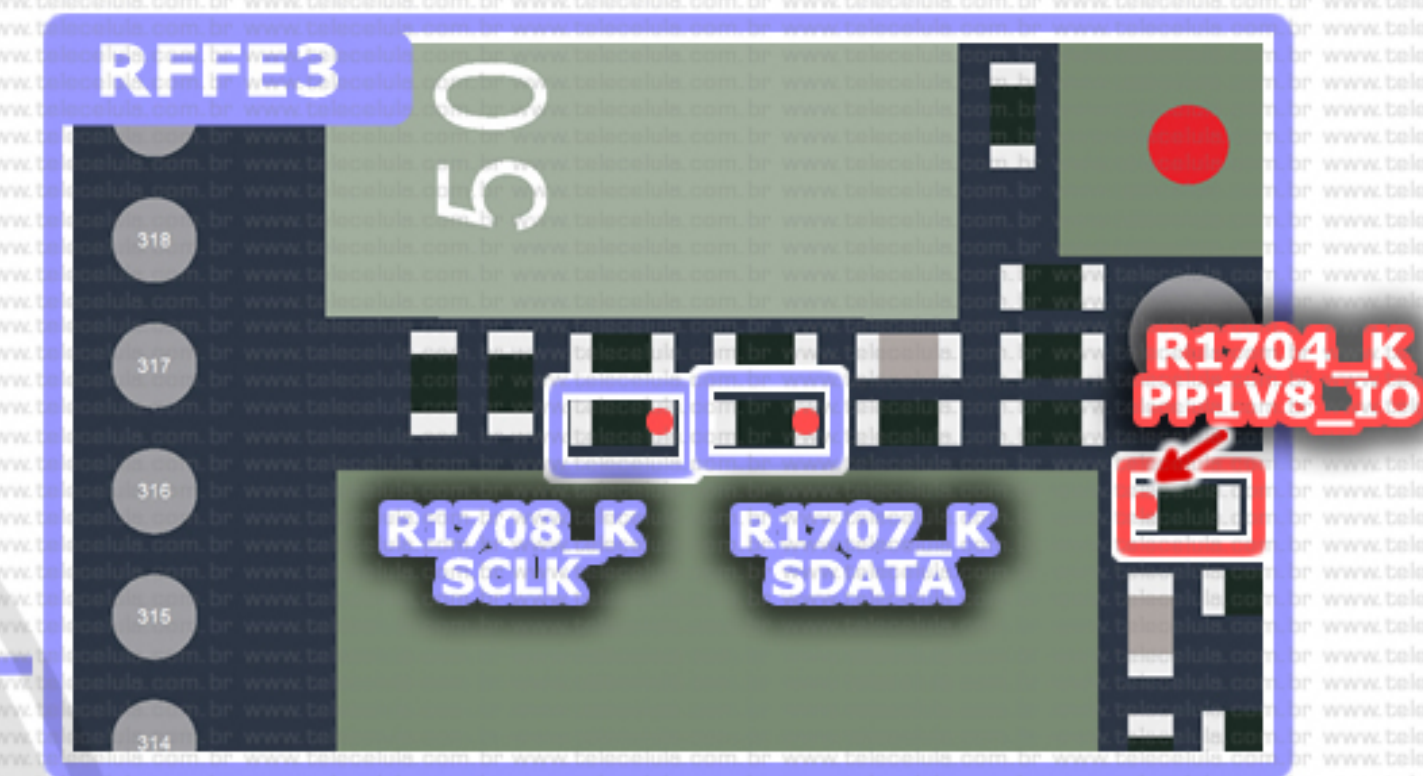
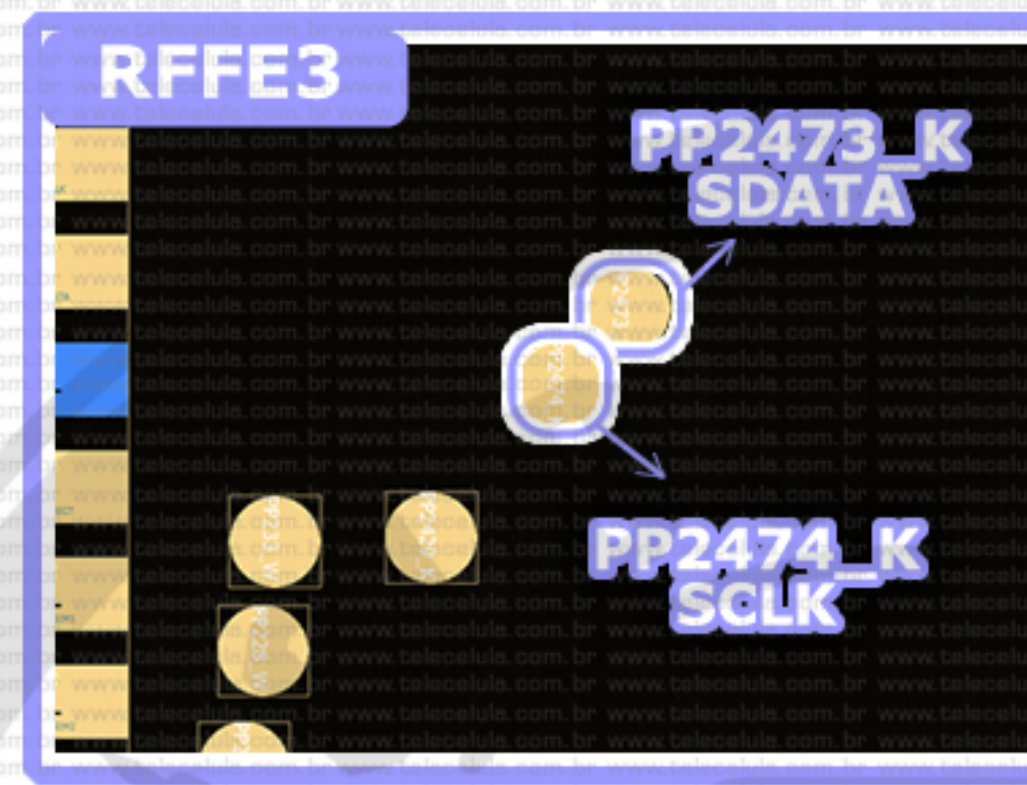
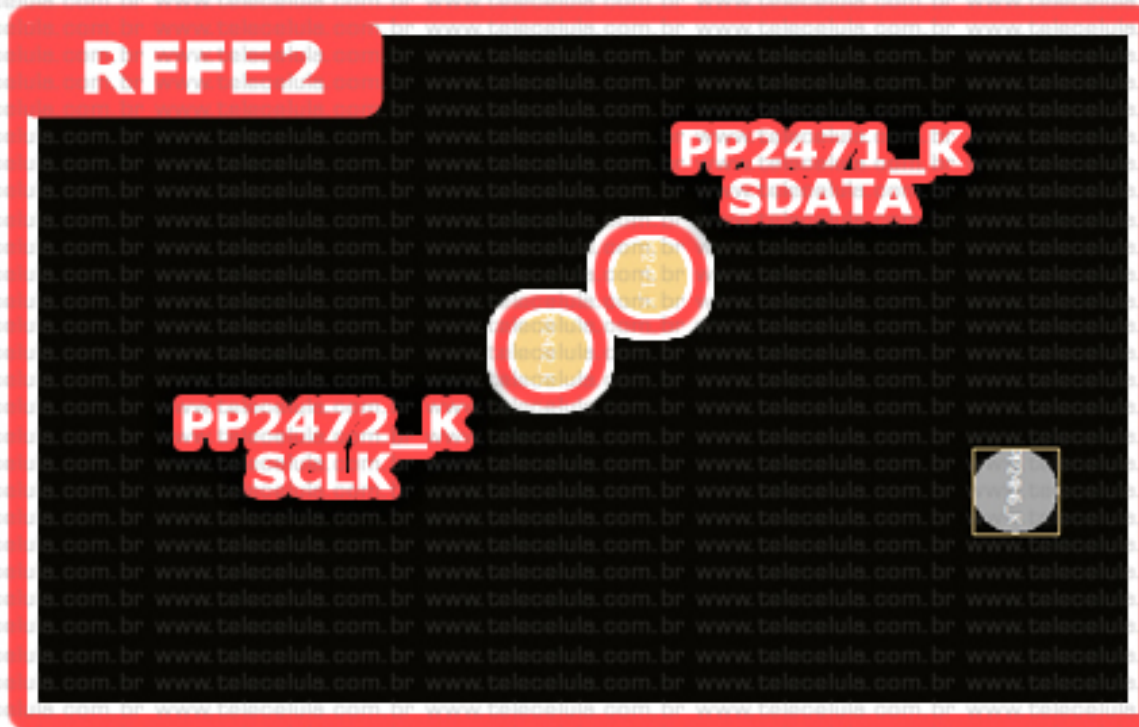

RFFE 2

RFFE 3

SHIELD RFFE TX SCLK

XCVR TO FE RX RFFE 3

SKY13775	CPL_K	0x6
QM81019	U_ET2_K	0xC
AFEM 8092_AP1	PA_HB_K	2G 0x3
SKY78170	PA_LB_L	0x2
HRPDAF092	PA_UHB_K	0x5
	PP1V8_IO PP24J2_K / PP24E8_K	

SKY78170	PA_LB_L	0xD
AFEM 8092_AP1	PA_HB_K	0xE
HRPDAF092	PA_UHB_K	0xC
	PP1V8_IO PP24J2_K / PP24E8_K	

SKY13768	DSM_HB_K LNA	0xA
SKY13765	DSM_LB_K	0x9
HFQRXRCJB_500	DSM44U_K MIMO RDM	0x4
SKY85759	U_5G U_W UAT	0x6
SKY85759	U_5G L_W LAT MURATA	0x41 0x5 MURATA
HFQRXRCJB_500	DSM44L_K RPM MIMO	0x3

- SLCK
 - SDATA
 - GND
 - 1V8
- Necessary test points to read RFFE

CLOSED BOARD

BOARD OPEN

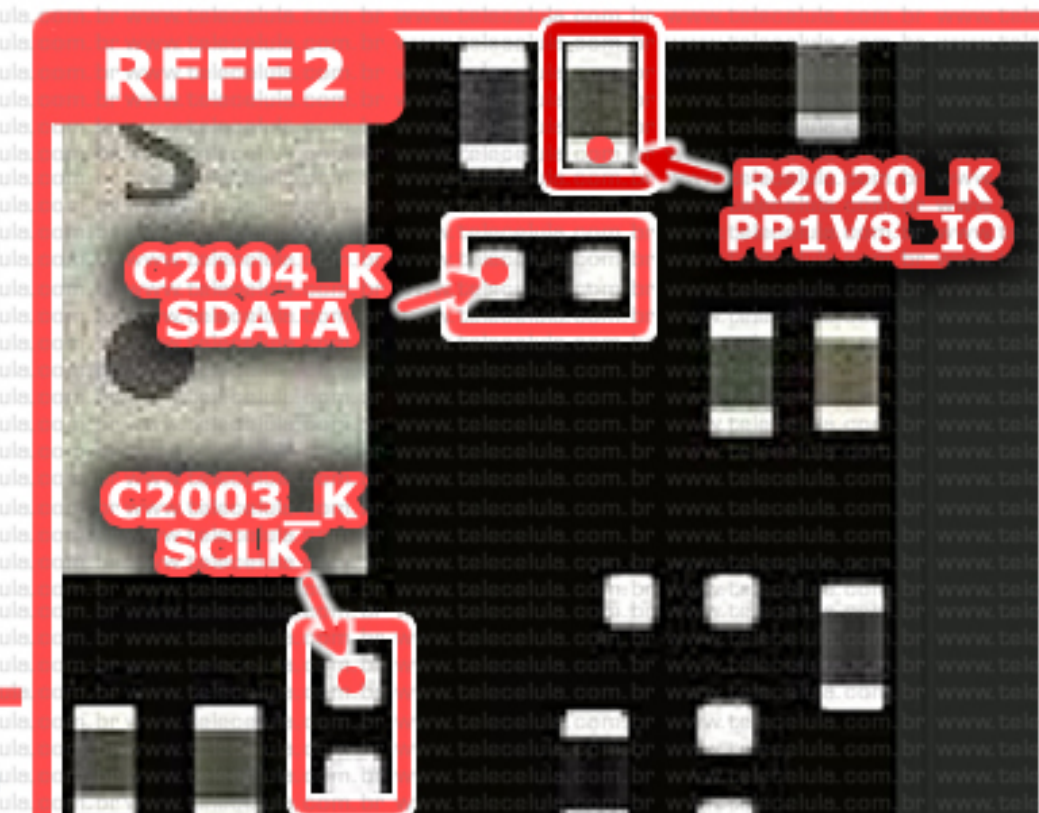
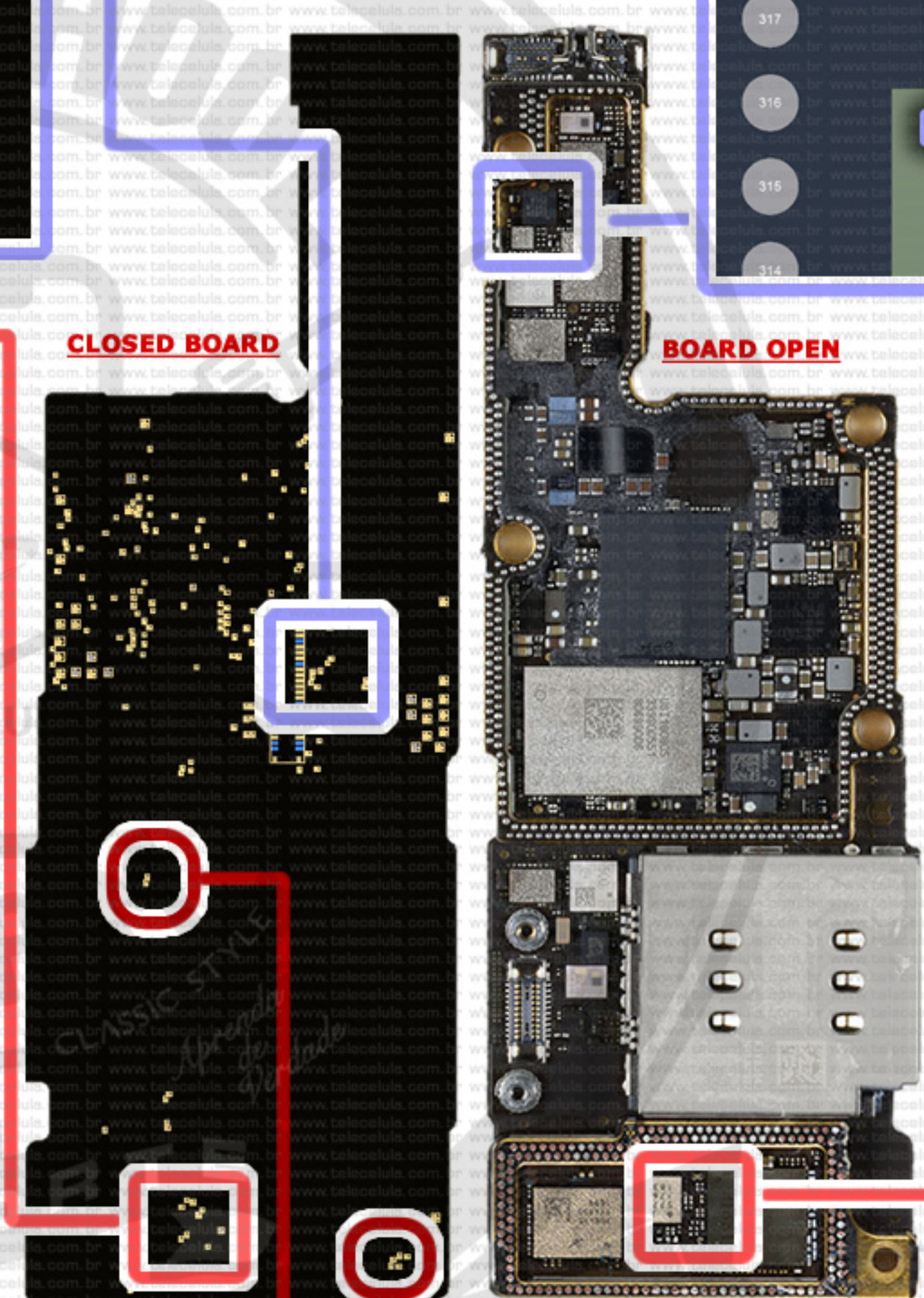

RFFE (XCVR_K)

IPHONE 11

APN: 820-01523-A

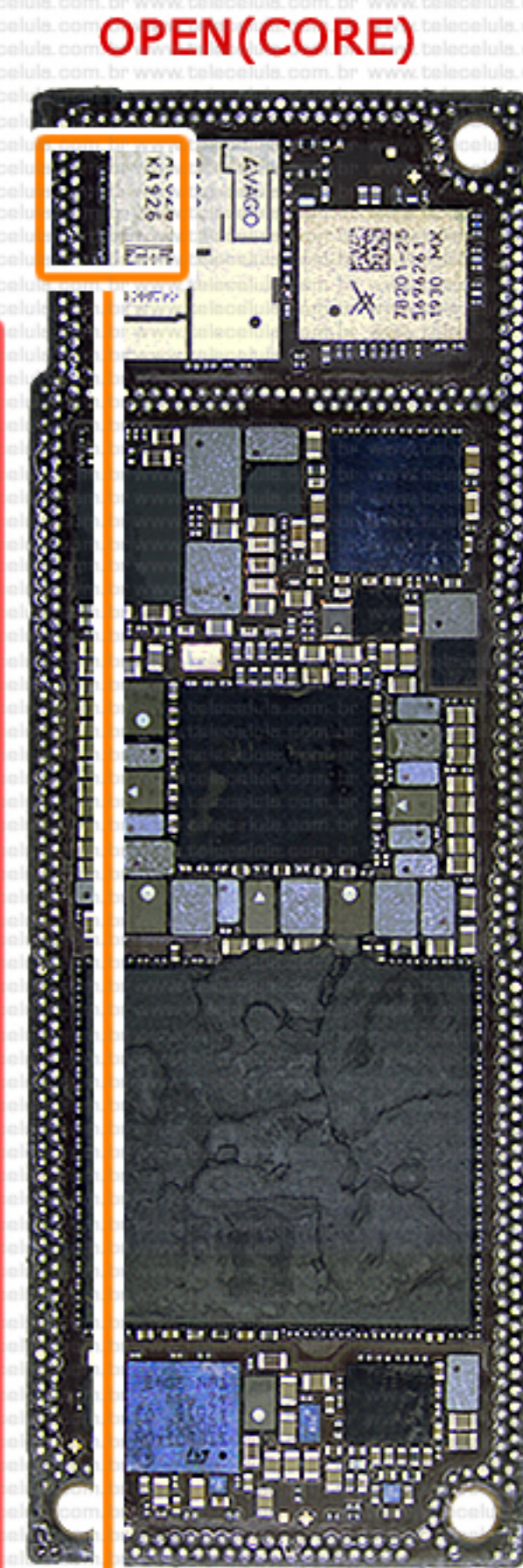
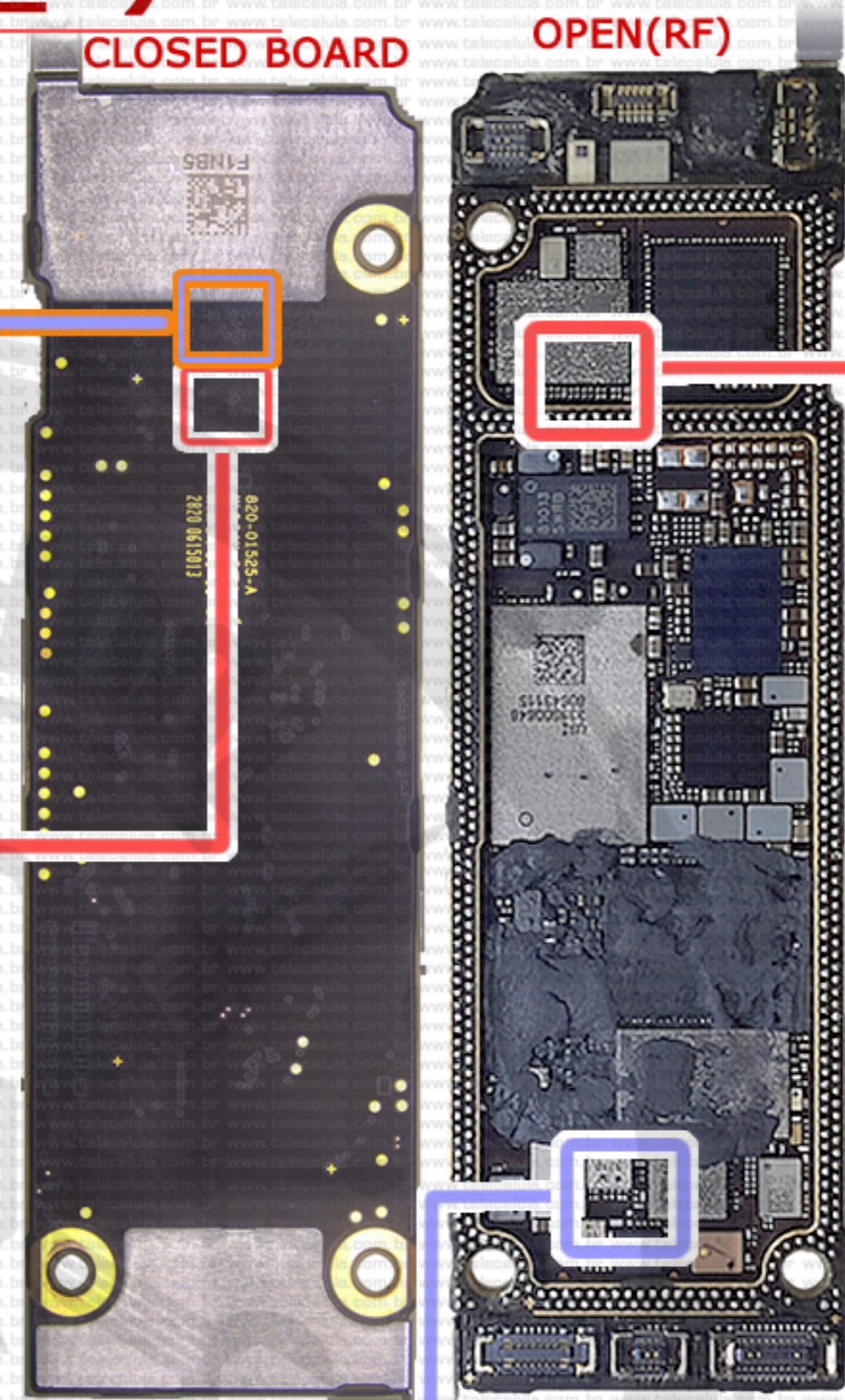
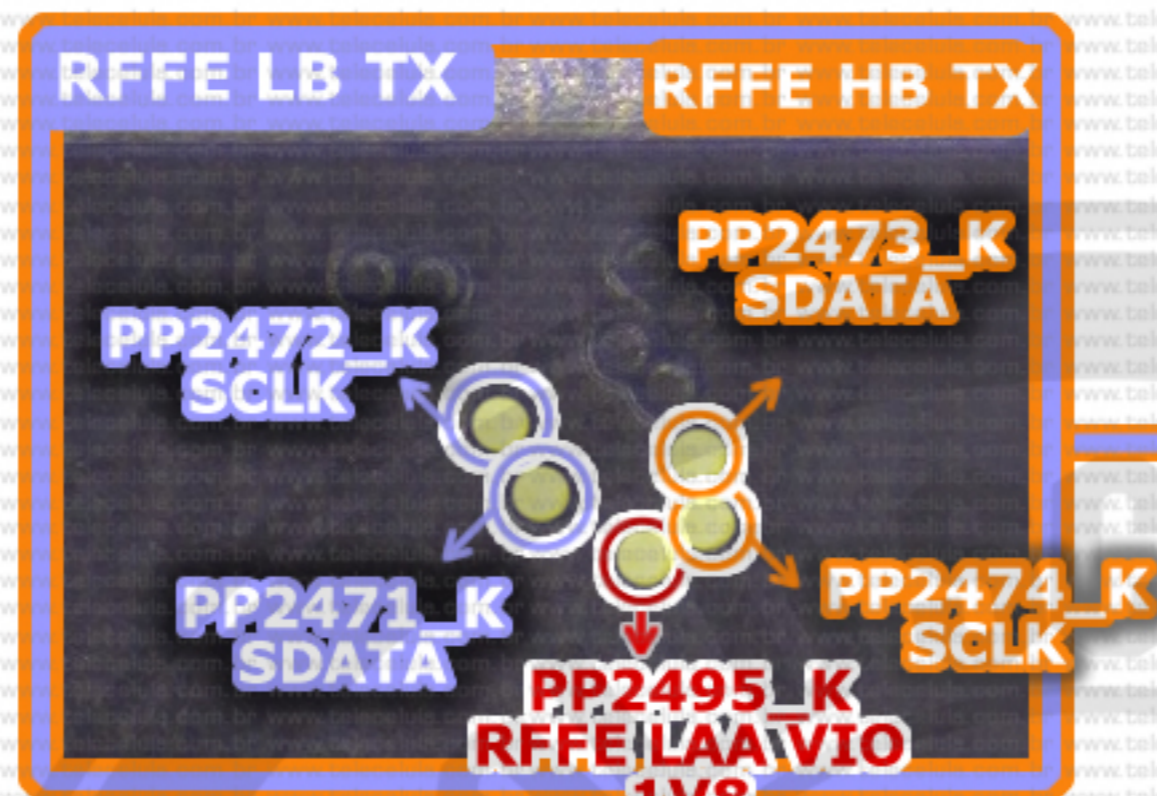
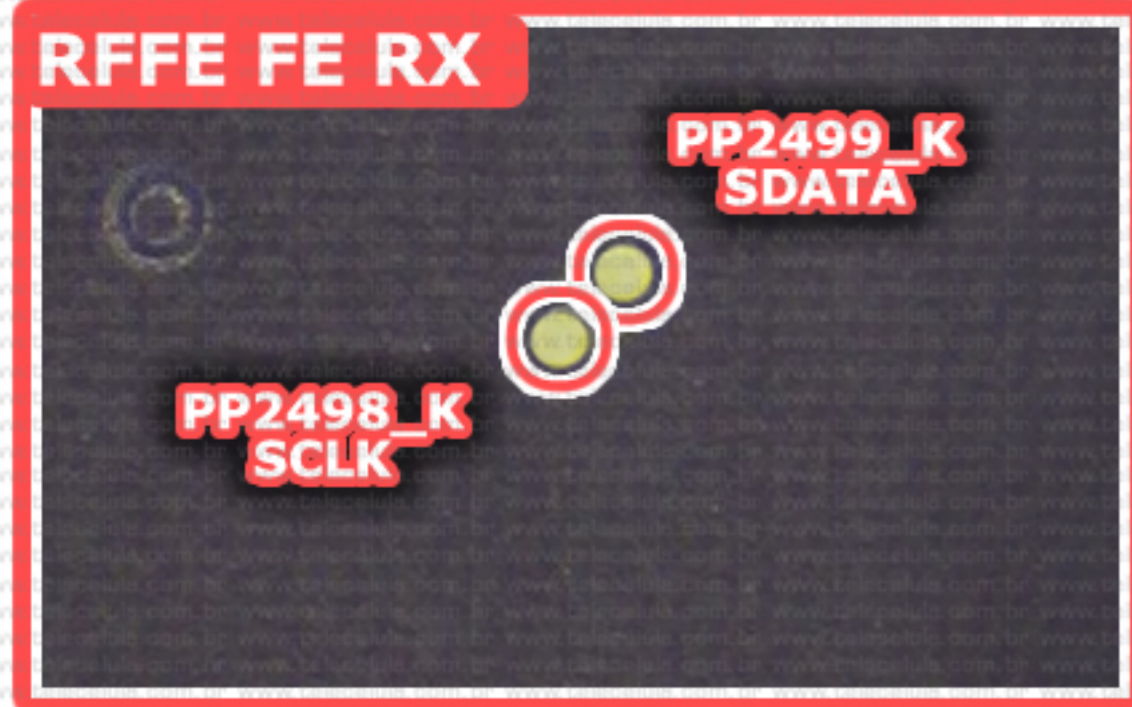

RFFE_LAA_UAT / RFFE_LAA_LAT
RFFE XCVR TO FE RX CLK

PA LB K	SKY78220	0xD
PA HB K	AFEM 8100_AP1	0xE
PA UHB K	2G	0xF
U 5G L W	MDFEGFFB_126	0x41
LAT/WI-FI/5G		0x5
DSM HB K	SKY13789	0xB
HB LNA		
DSM LB K	LMRXFRJB_K57	0xA
UAT_5G	MDFEGFFB_126	
U 5G U W		0x6
FEM		

RFFE XCVR TO LB TX DATA	QM81013	
ET ETIC_K		0xC
PA LB K	SKY78220	0x1
CPLR U K	SKY16710	0x9
UAT		
CPLR L K	SKY16710	0x8
LAT		
PA UHB K	UHB_MLB_2GS_PAD	0xF

RFFE XCVR TO HB TX DATA		
RFFE XCVR TO HB TX SCL		
PA_UHB_K	2G	0x3
PA_HB_K	ATEM_8100_AP1	0x2
ETIC_K	QM81013	0xC

- SLCK
- SDATA
- GND
- 1V8

Necessary test points to read RFFE

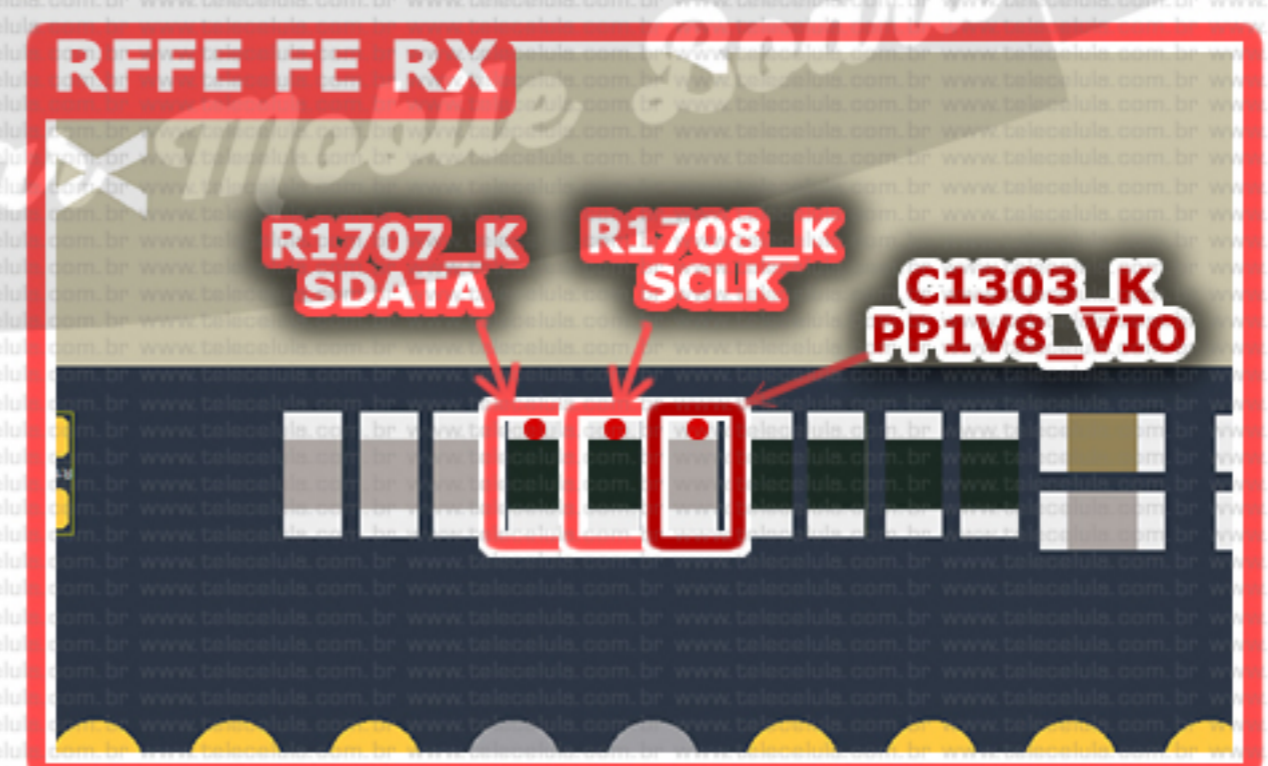
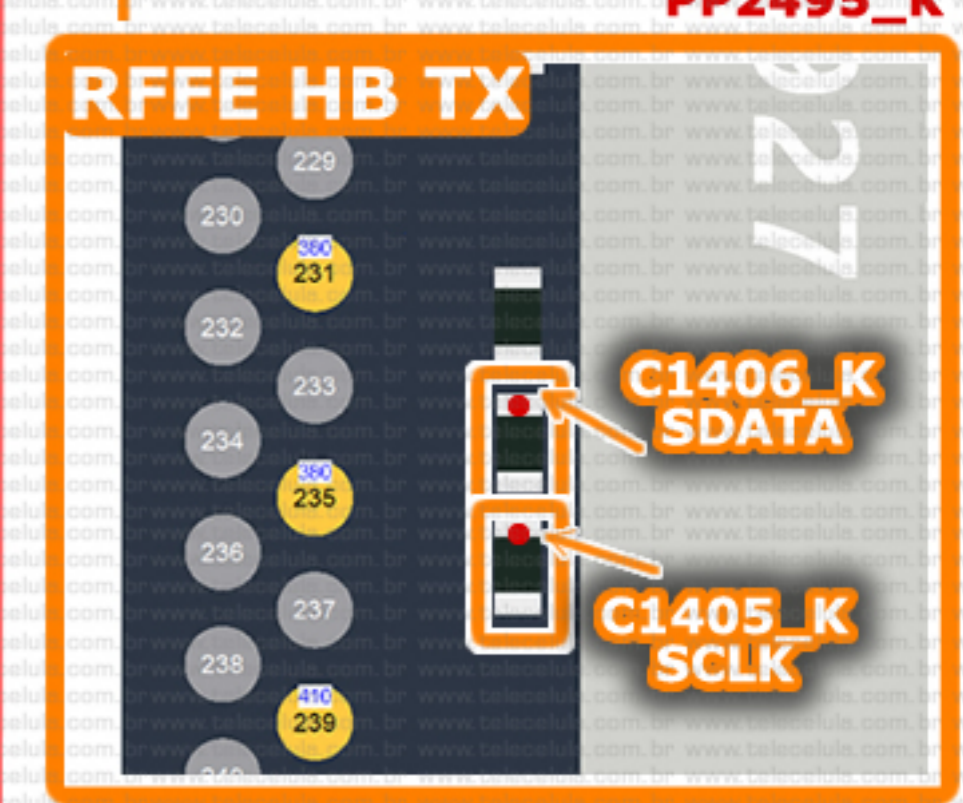
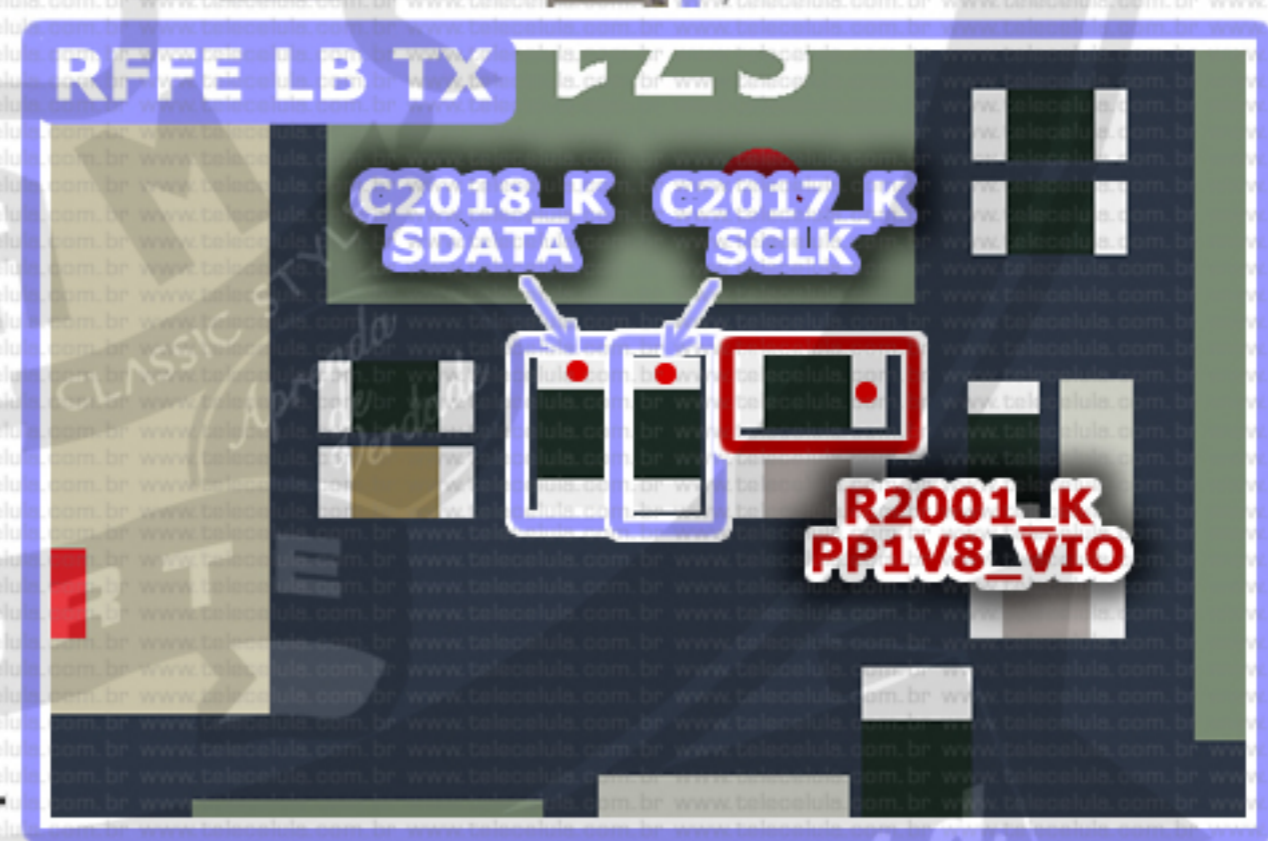

PP2495_K

PP2495_K - PP1V8_VIO

PP2495_K - PP1V8_VIO

IPHONE 11 PRO/ PRO MAX

APN: 820-01682-08 | APN: 820-00189-A

RFFE - XCVR

CLOSED BOARD

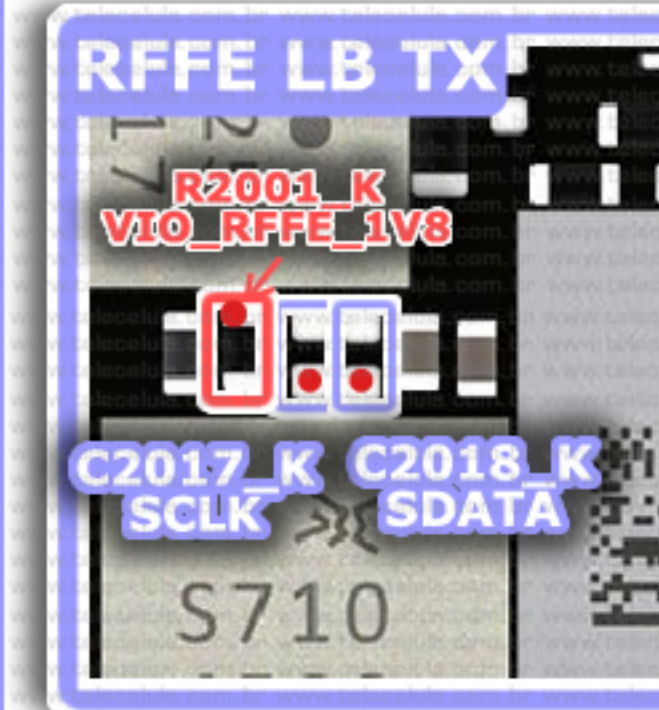
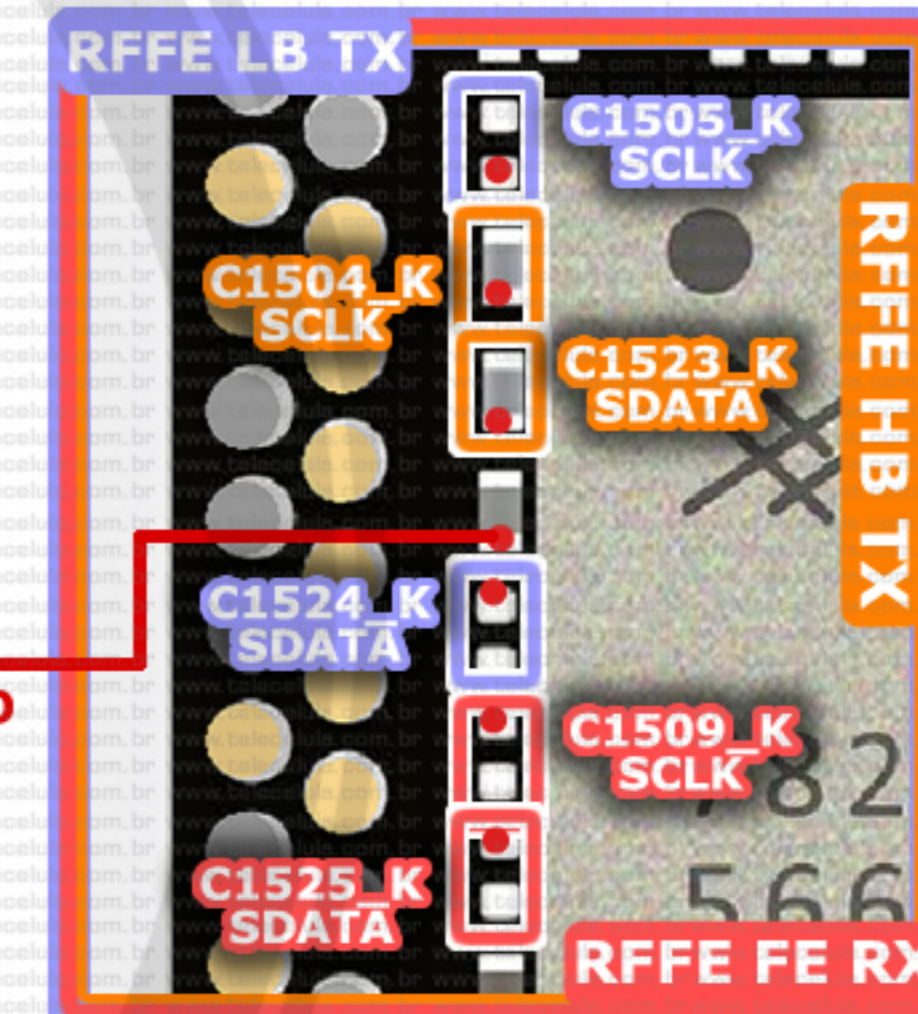
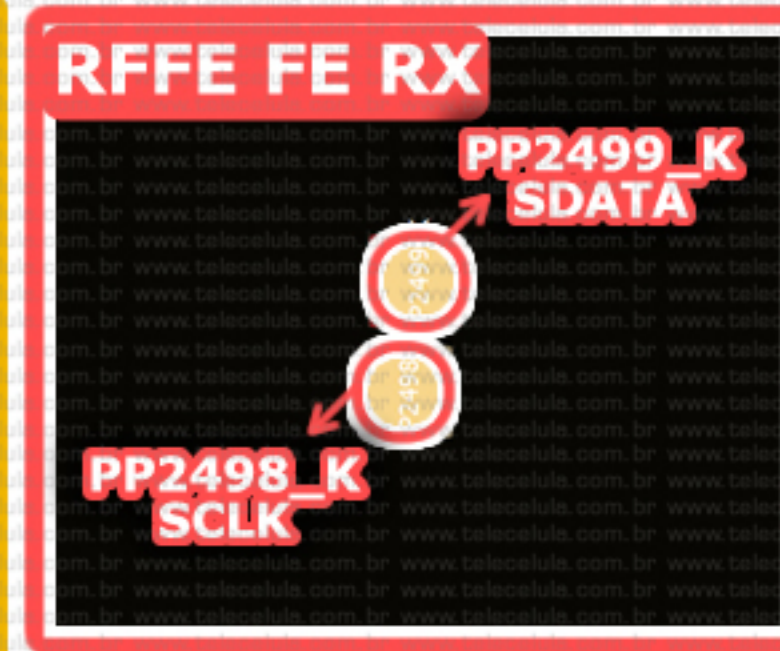
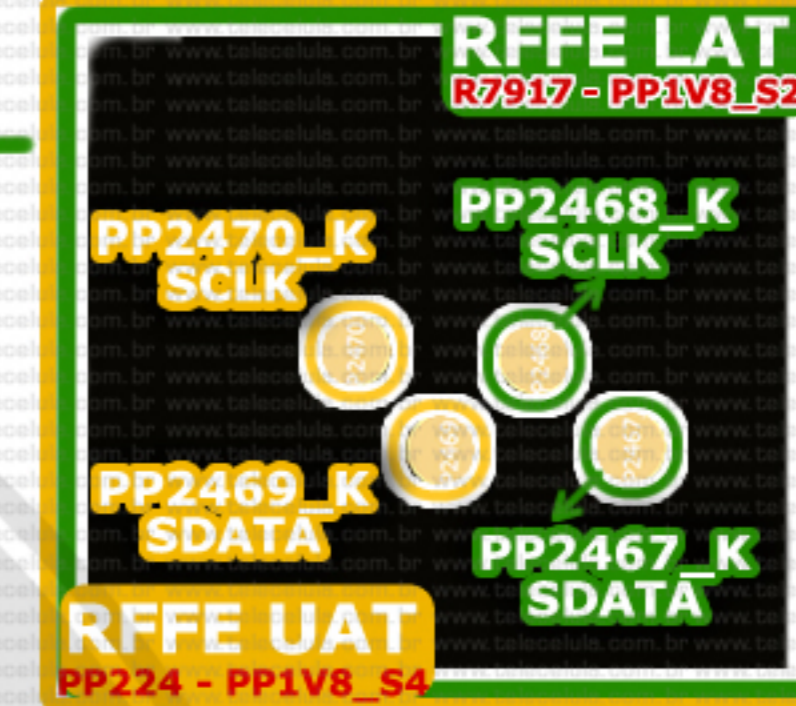
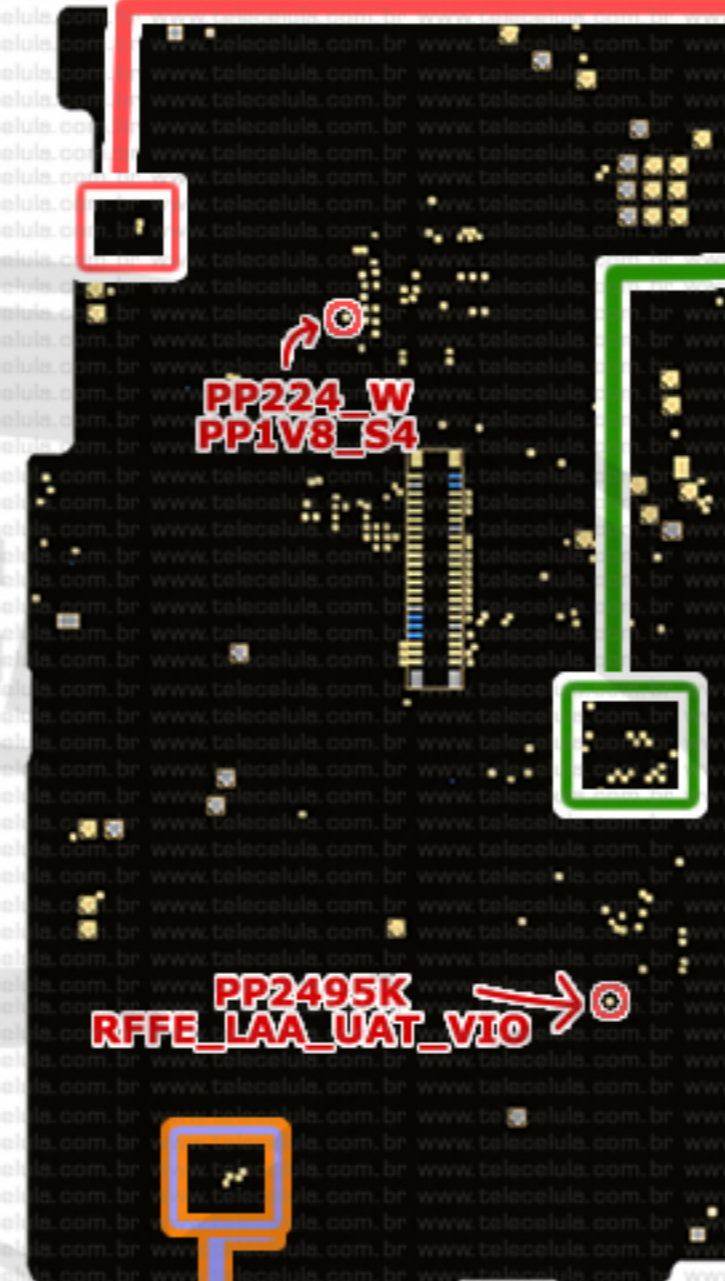
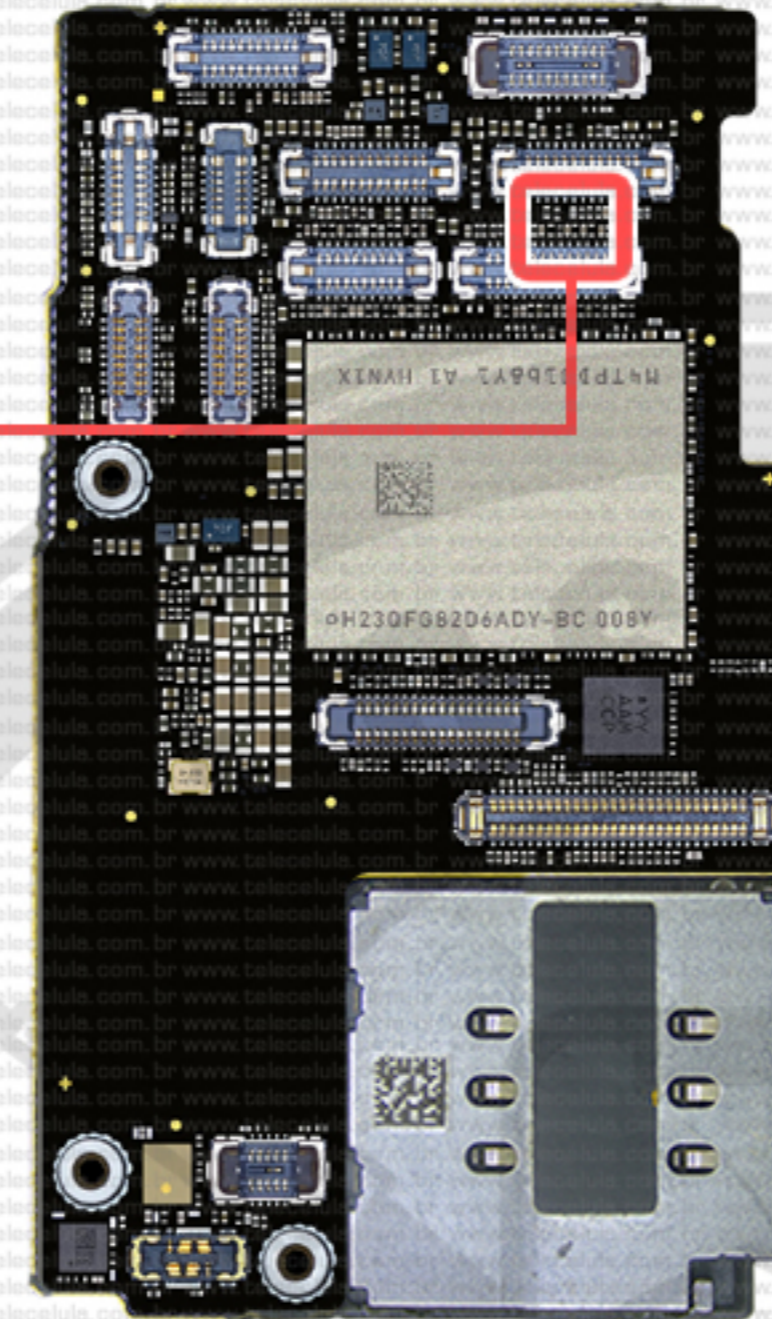
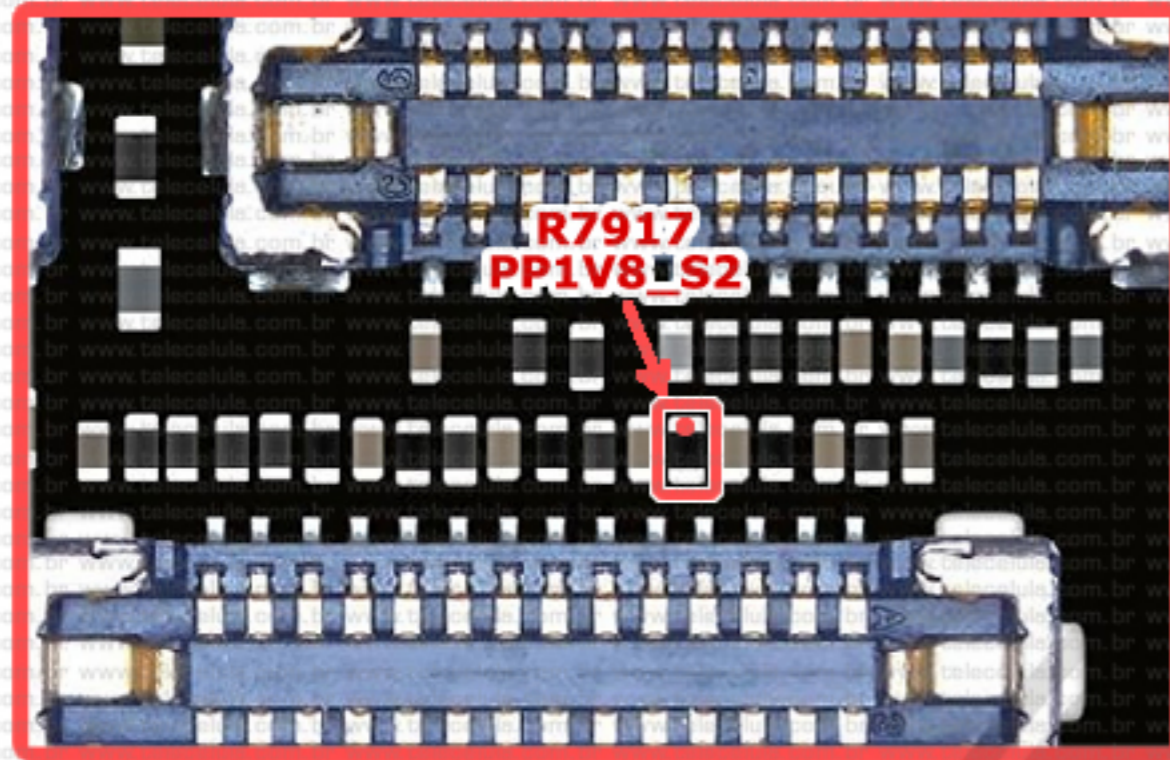

RFFE XCVR TO FE RX CLK

SKY78220
PA LB K 0xD

HFQRXRJDB 728
MIMODS K 0x7

AFEM 8100_AP1
PA HB K 0xE

UHB_2GS_PAD
PA UHB K 0xF

MDFEGFFB_126
U 5G L W 0x41
WI-FI/5G 0x5

SKY13787
DSM HB K 0xB
HB LNA

LMRXFRJB_K57
DSM LB K 0xA

MDFEGFFB_126
U 5G U W 0x41
FEM 0x6

PP2495_K RFFE_LAA_UAT_VIO

- SLCK
- SDATA
- GND
- 1V8*

Necessary test points to read RFFE

RFFE XCVR TO LB TX DATA

QM81013
ETIC_K 0xC

SKY78220
PA_LB_K 0x1

SKY16710
CPLR_U_K 0x9
COUPLER

SKY16710
CPLR_L_K 0x8
COUPLER

UHB_2GS_PAD
PA_UHB_K 2G 0x3

PP2495_K RFFE_LAA_UAT_VIO

RFFE BB TO LAT DATA RFFE BB TO LAT SCL

QM18833
LAT_SUBUS
LATTUN_K 0x8

R7917 - PP1V8_S2

RFFE XCVR TO HB TX DATA RFFE XCVR TO HB TX SCL

UHB_2GS_PAD
PA_UHB_K 0x3 0xF

ATEM_8100_AP1
PA_HB_K 0x2

QM81013
ETIC_K 0xC

PP2495_K RFFE_LAA_UAT_VIO

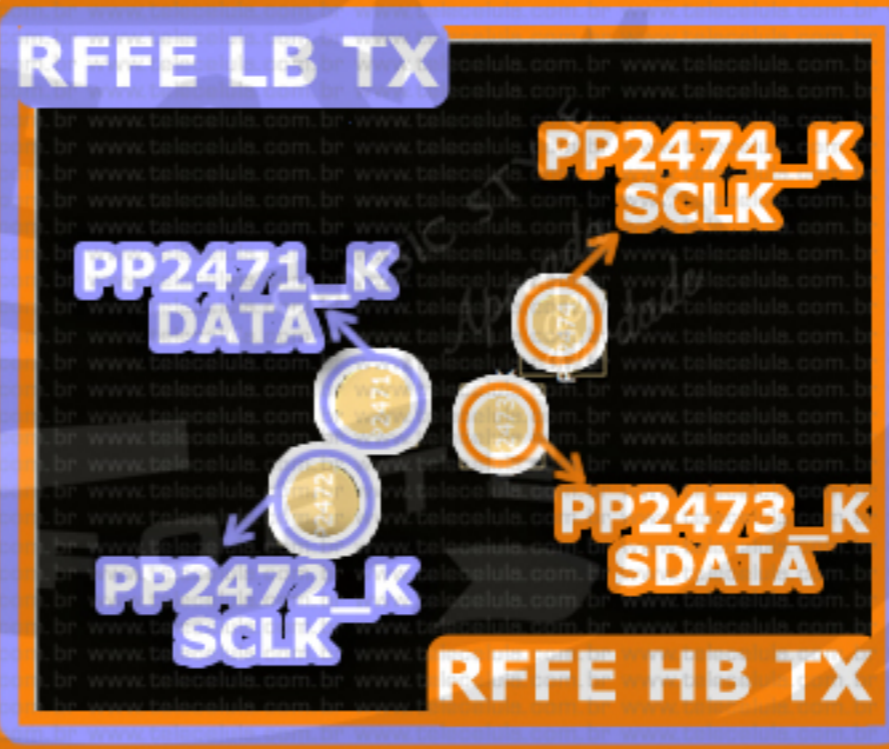

RFFE BB TO UAT

QM18833
UATTUN_K 0x8

PP224_W VDD1V8_S4

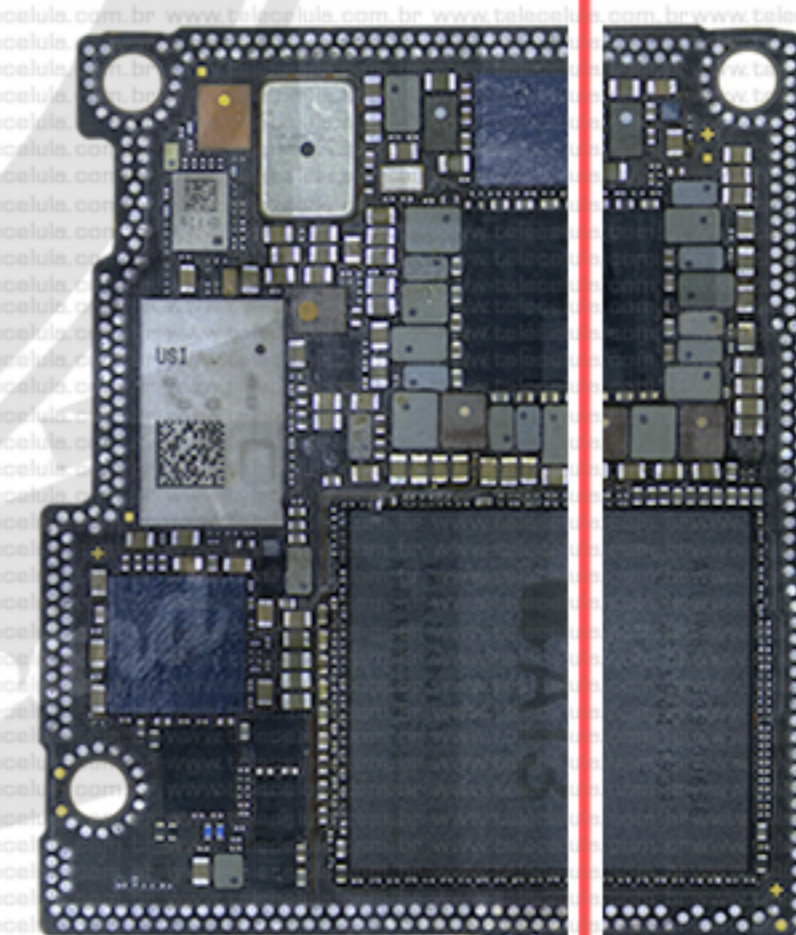

OPEN BOARD

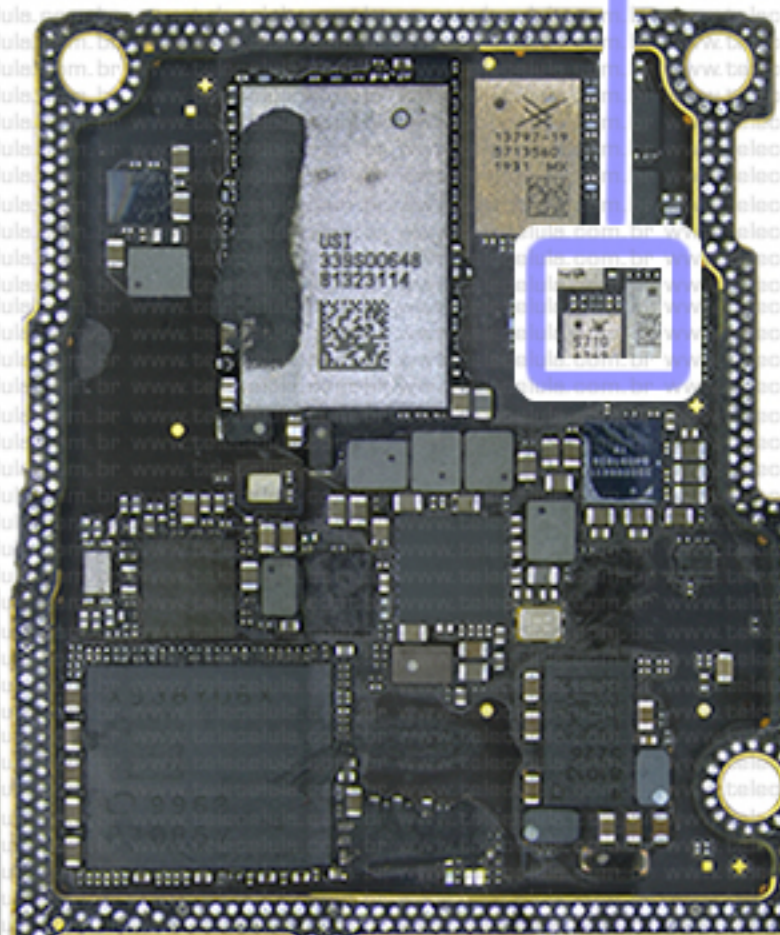

OPEN BOARD

RFFE - (U_SDRE)

CLOSED BOARD

IPHONE 12 MINI

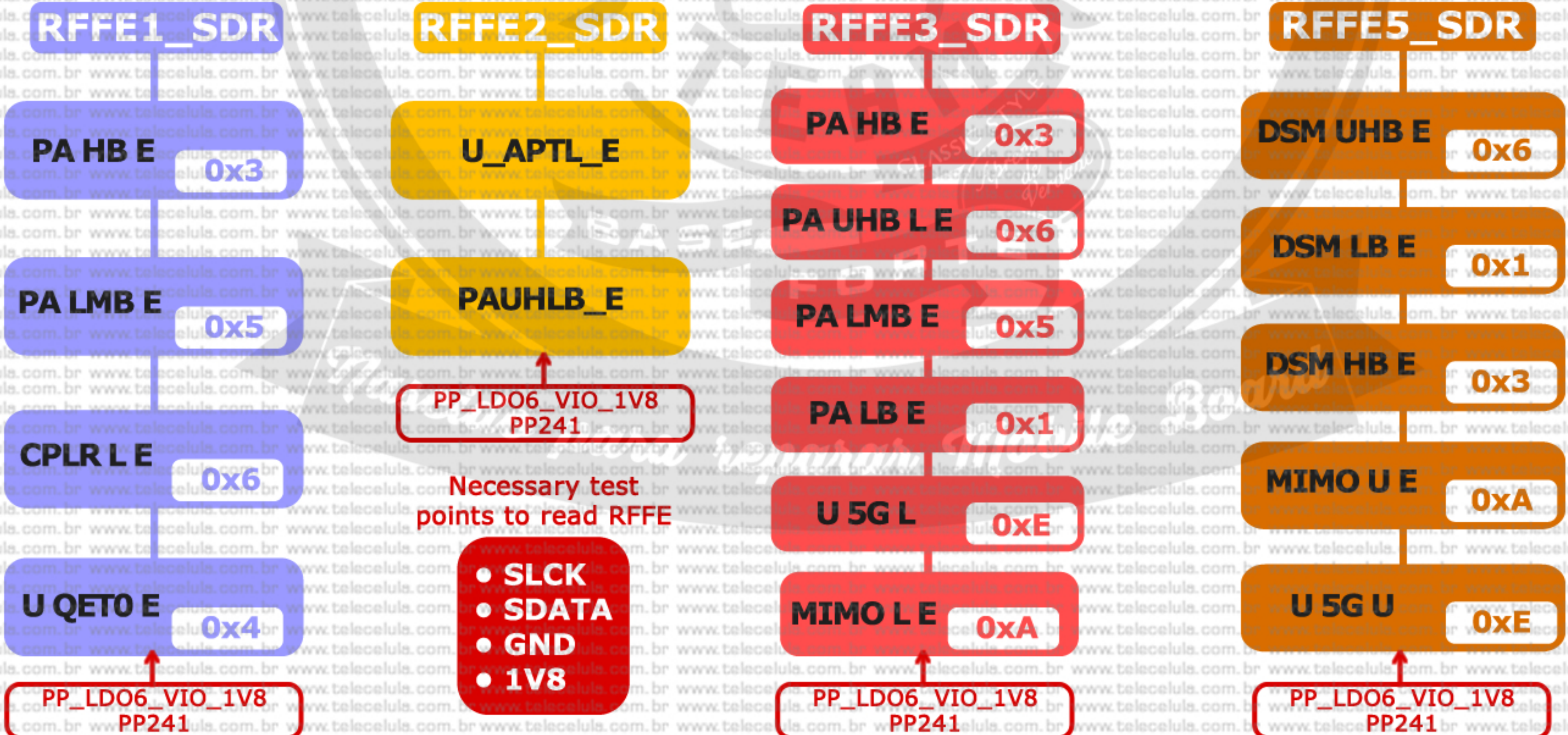
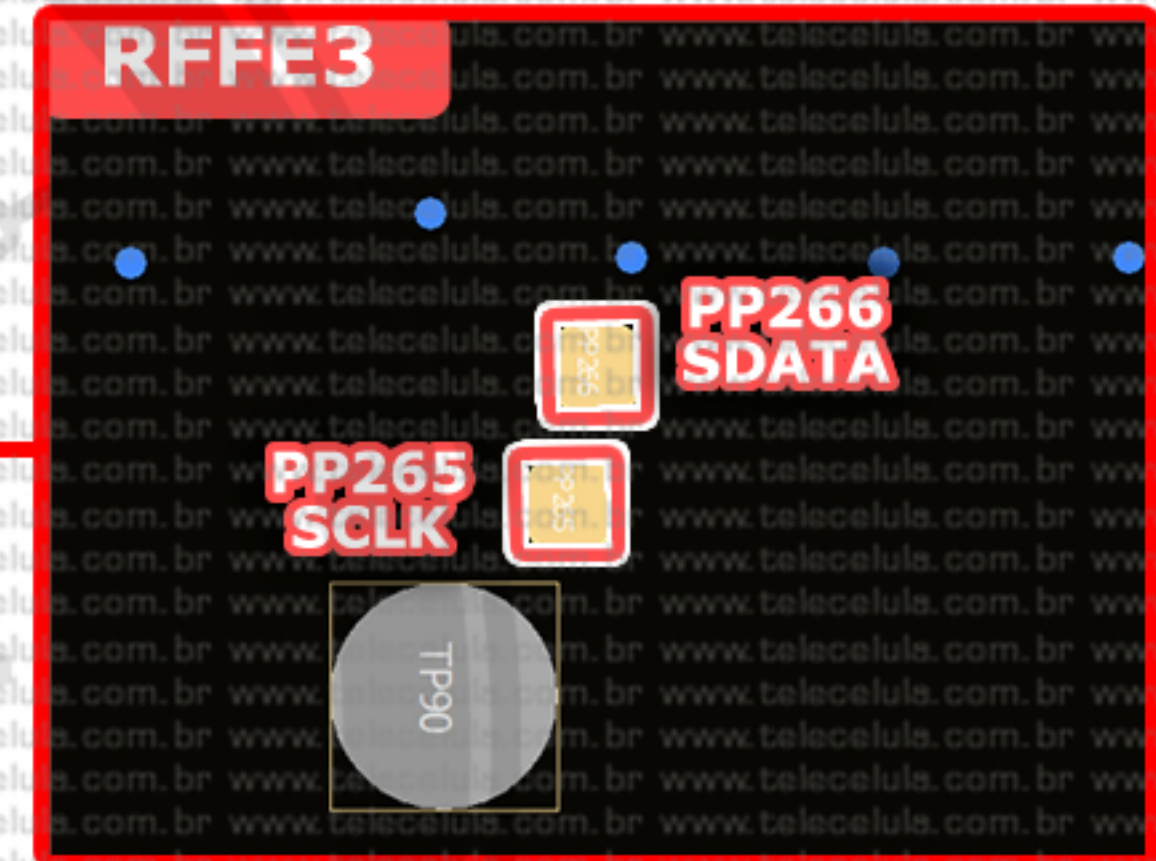
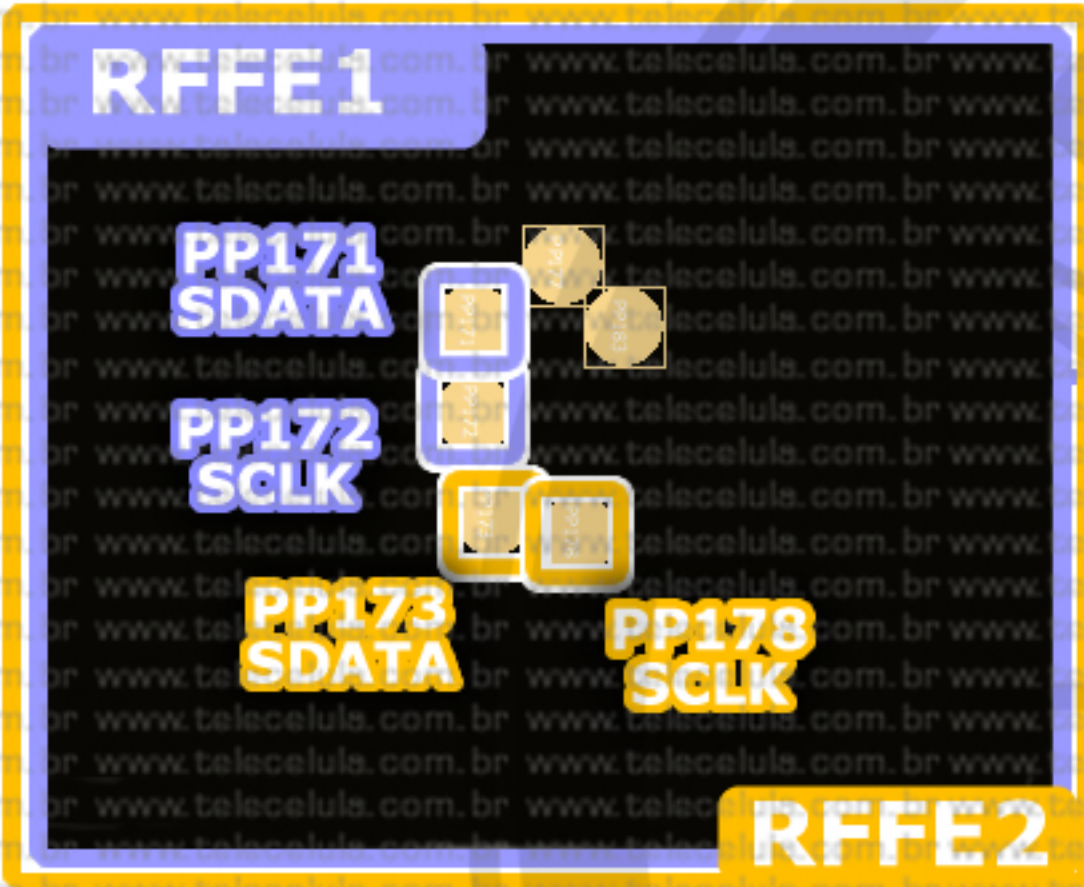
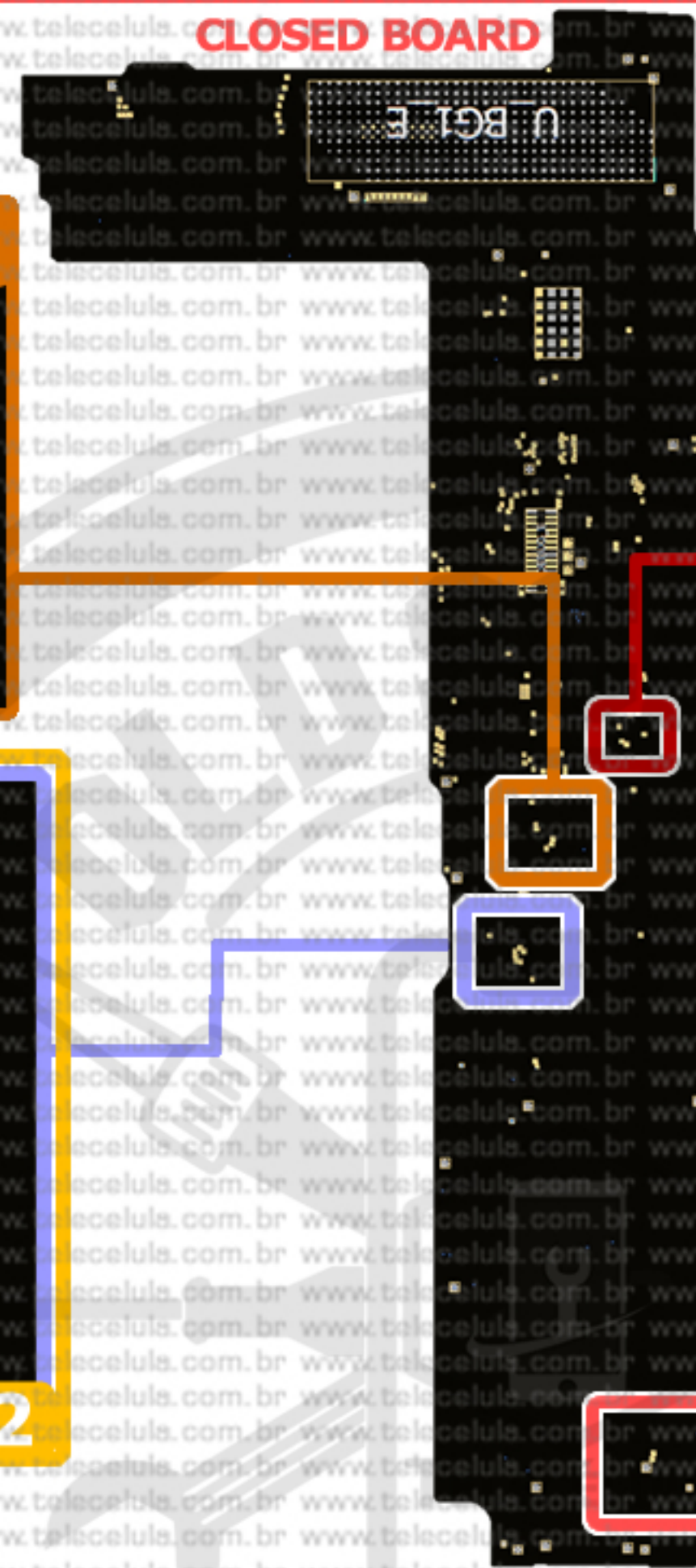

RFFE - SDR

IPHONE 12 / 12 PRO

CLOSED BOARD

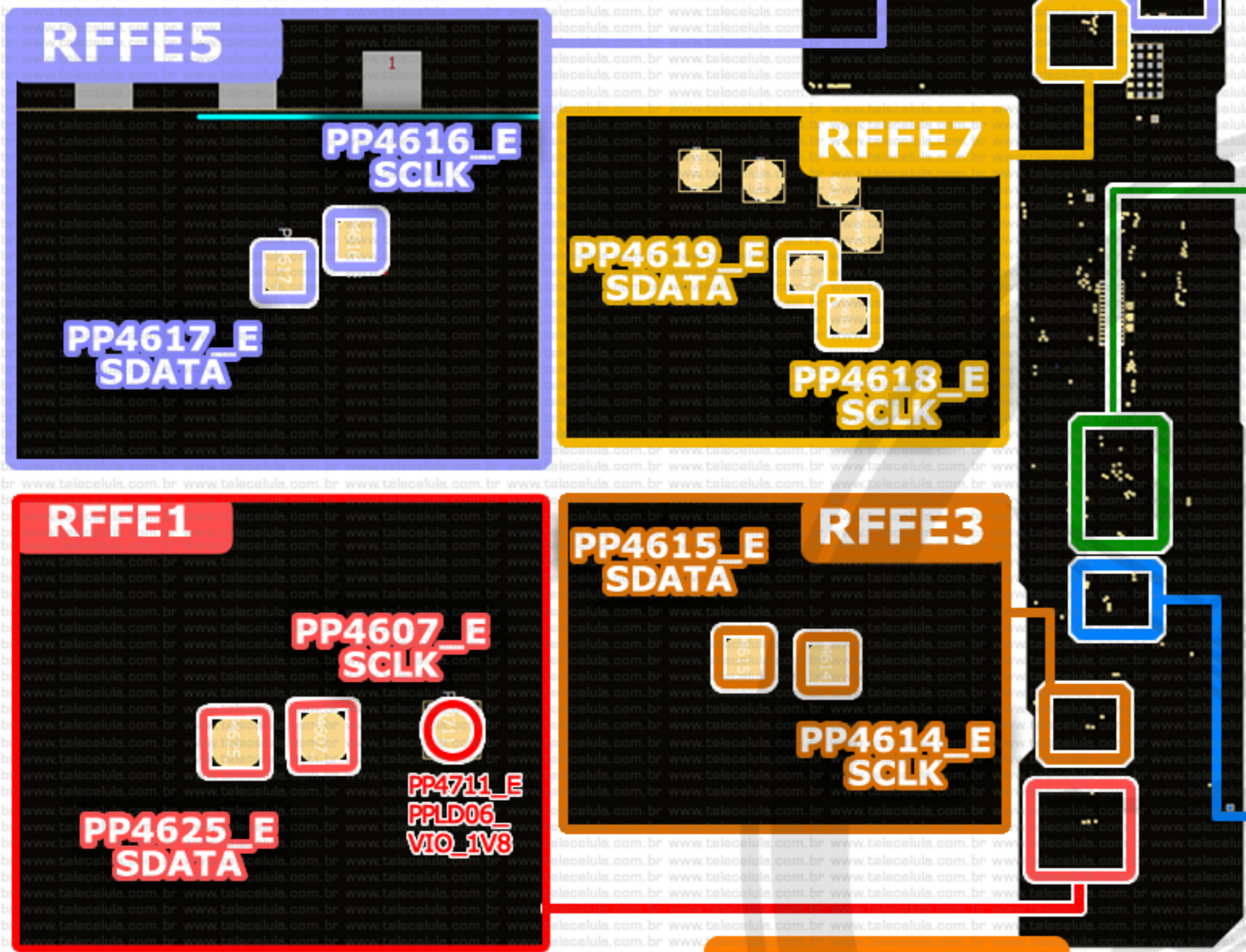

OPEN BOARD

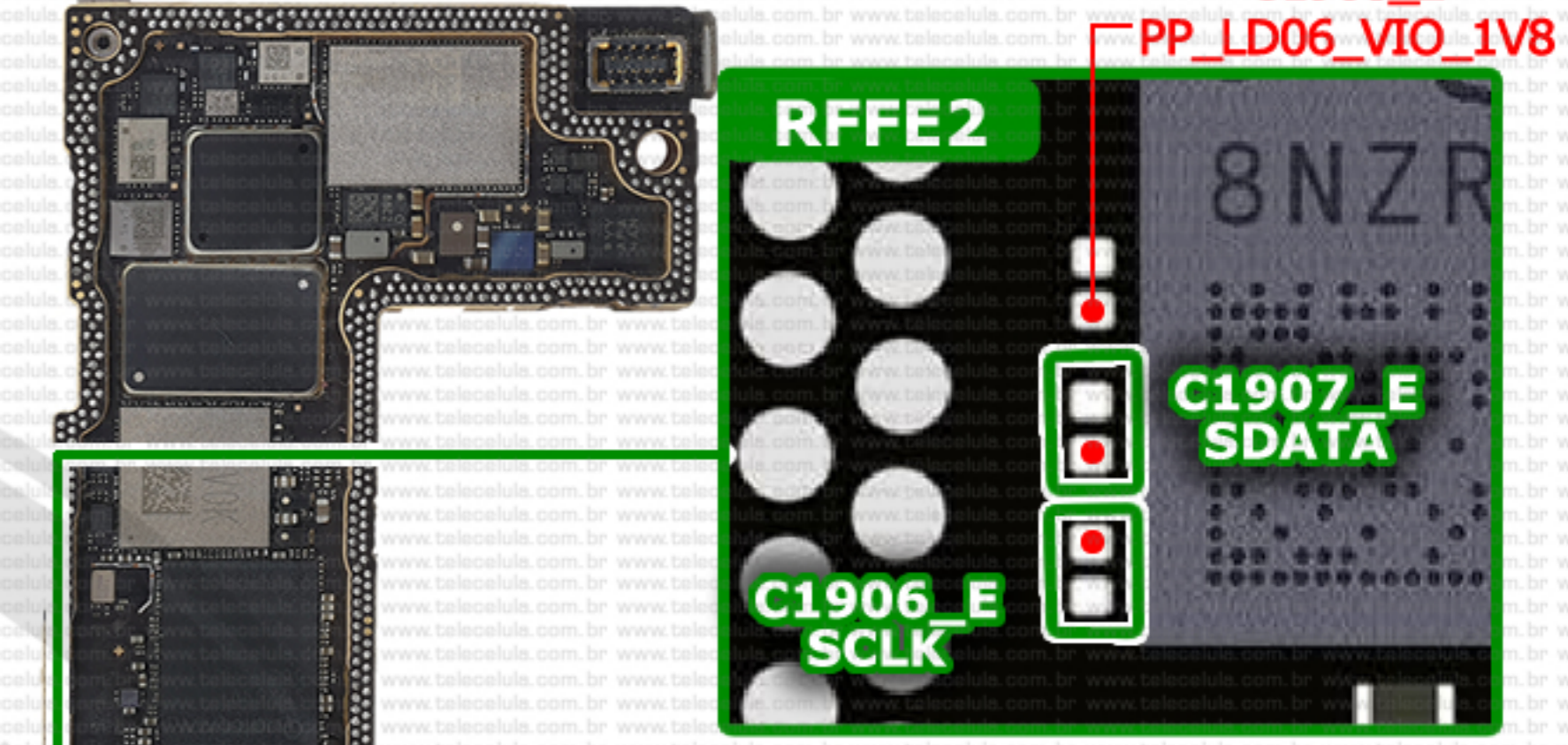

Necessary test points to read RFFE

- SCLK
 - SDATA
 - GND
 - 1V8
- LB: 2G
MB: 3G
HB: 4G
N77/N79: 5G

RFFE1_SDR

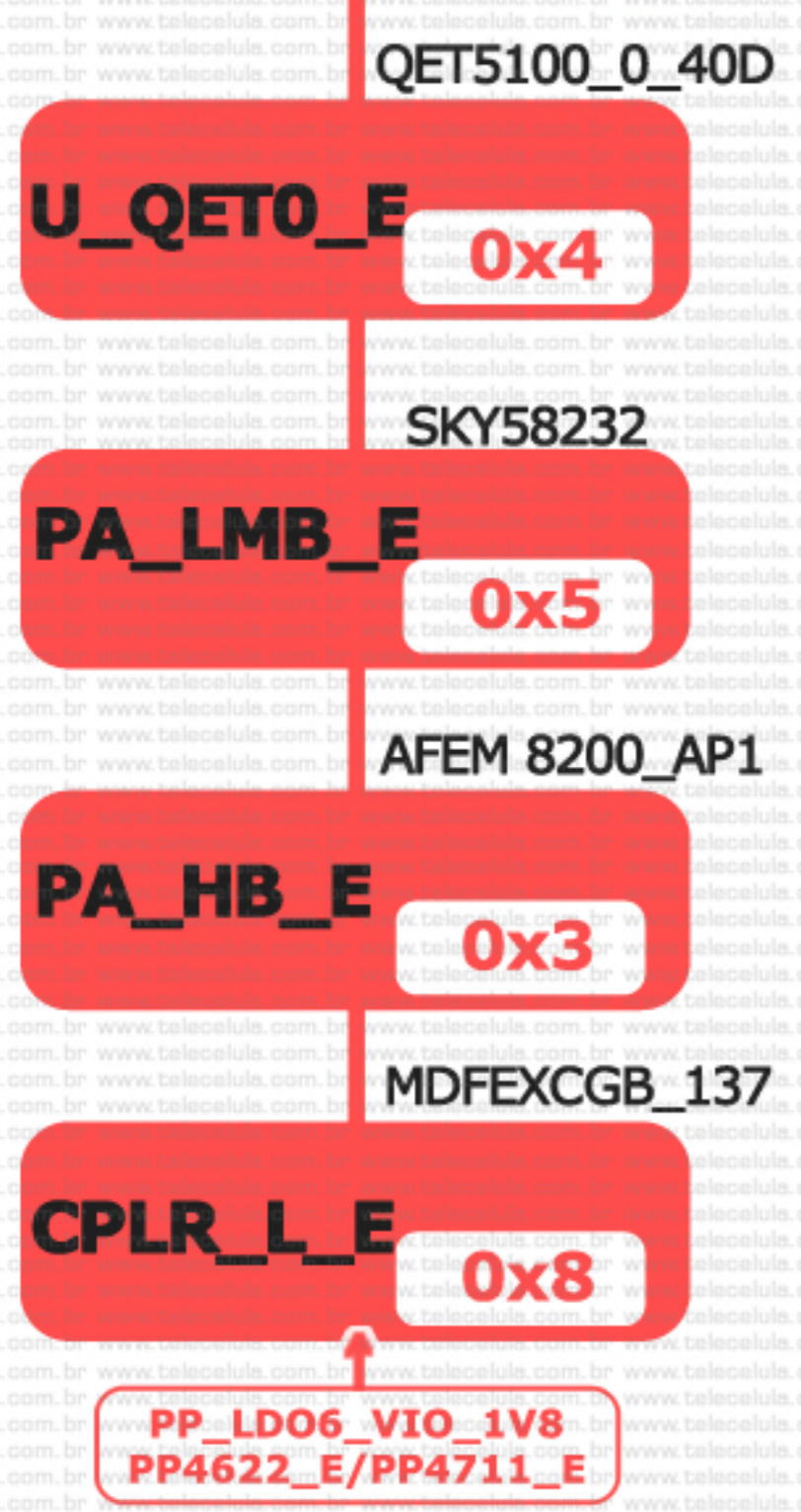

RFFE3_SDR



RFFE5_SDR



RFFE7_SDR



RFFE2_SDR

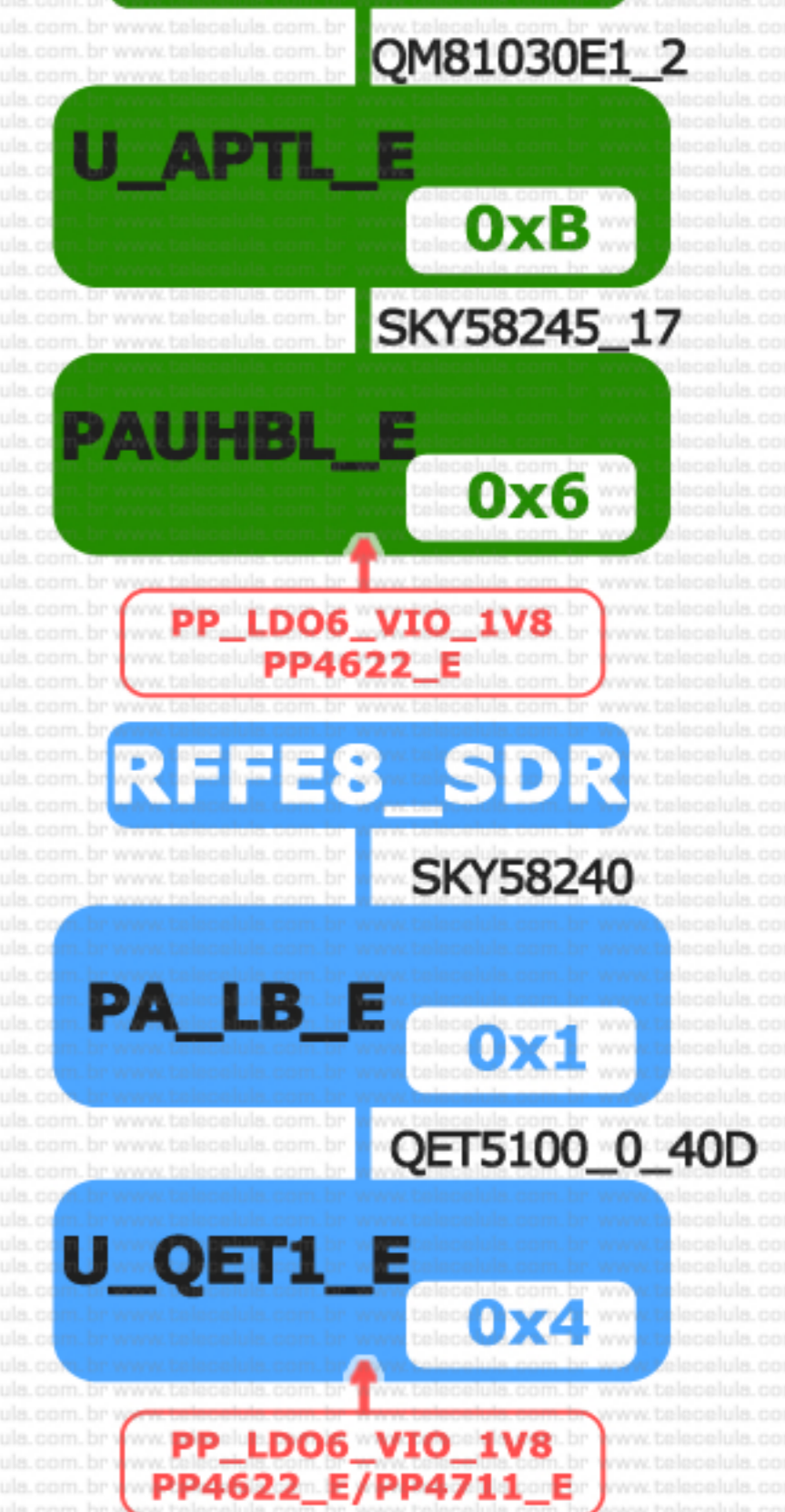

SMARTBOARD - IPHONE 12 PRO MAX

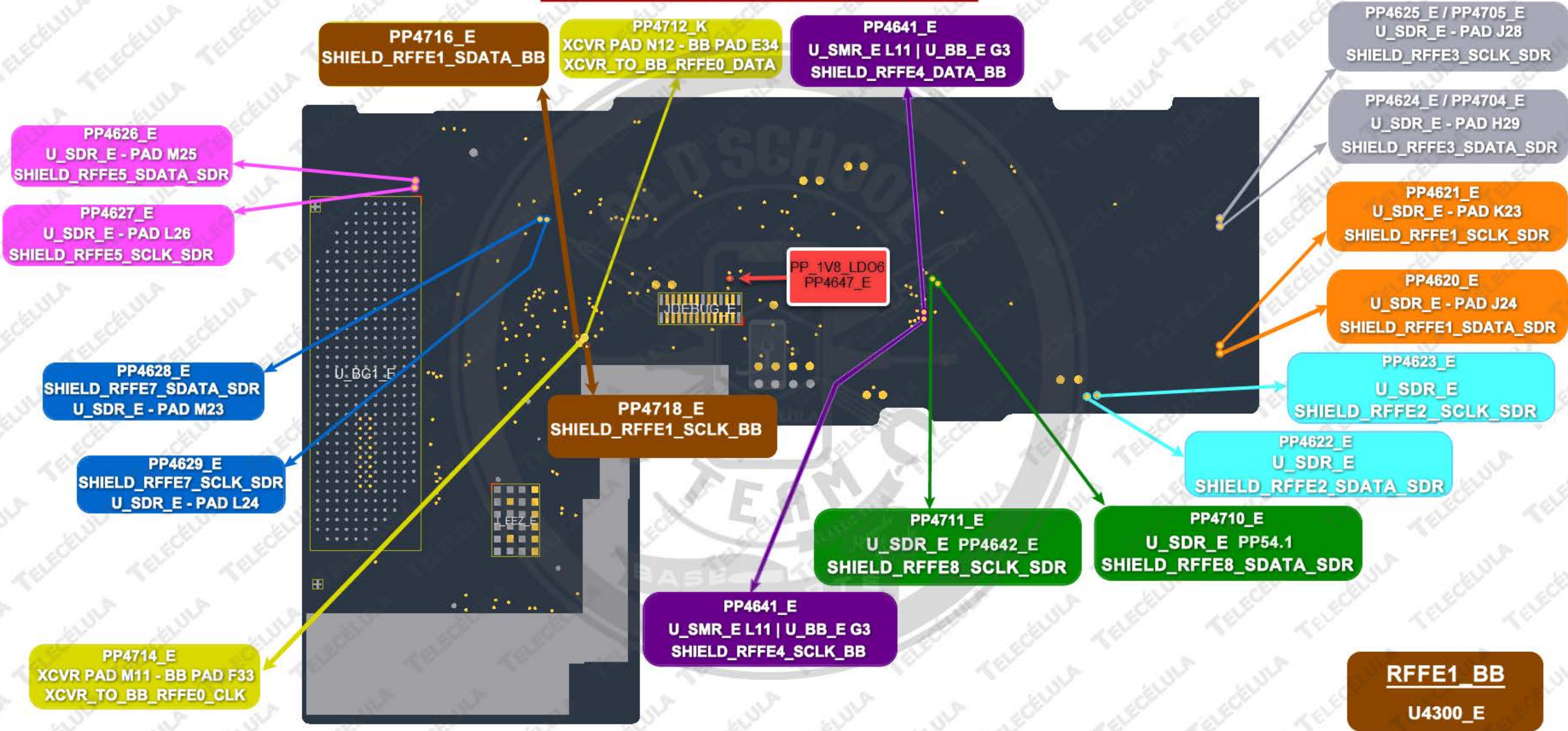

IPHONE 12 PRO MAX



SMARTBOARD - IPHONE 13

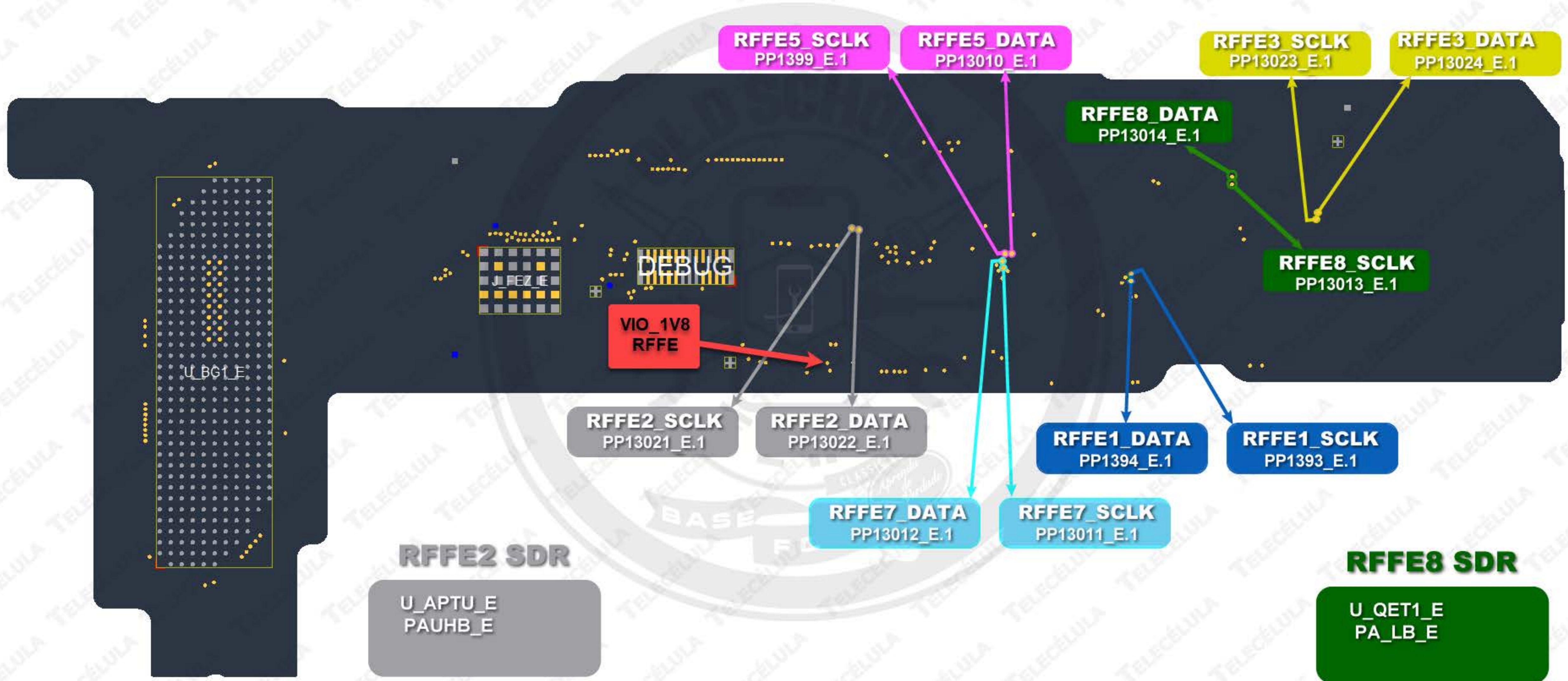

RFFE1 SDR

PA_HB_E	0x3
PA_2G_E	0x5
CPLR_L_E	0x8
U_QET0_E	0x4

RFFE3 SDR

PA_HB_E	0x3
PAUHB_E	0x6
MIMO_L_E	0xA
PA_LB_E	0x1
U_5G_L_W	0xE

RFFE7 SDR

UAPTL_E	0xB
CPLR_U_E	0x8
DSM_HB_E	0x3

RFFE5 SDR

DSM_LB_E	0x1
DSM_HB_E	0x3
U_5G_U_W	0xE
MIMO_U_E	0xA
DSM_UHB_E	0x7

RFFE5_SCLK
PP1399_E.1

RFFE5_DATA
PP13010_E.1

RFFE3_SCLK
PP13023_E.1

RFFE3_DATA
PP13024_E.1

RFFE8_DATA
PP13014_E.1

RFFE8_SCLK
PP13013_E.1

RFFE2_SCLK
PP13021_E.1

RFFE2_DATA
PP13022_E.1

RFFE1_DATA
PP1394_E.1

RFFE1_SCLK
PP1393_E.1

RFFE7_DATA
PP13012_E.1

RFFE7_SCLK
PP13011_E.1

RFFE2 SDR

U_APTU_E
PAUHB_E

RFFE8 SDR

U_QET1_E
PA_LB_E

IPHONE 13 MINI - RFFE SDR 868

MOUNTED BOARD

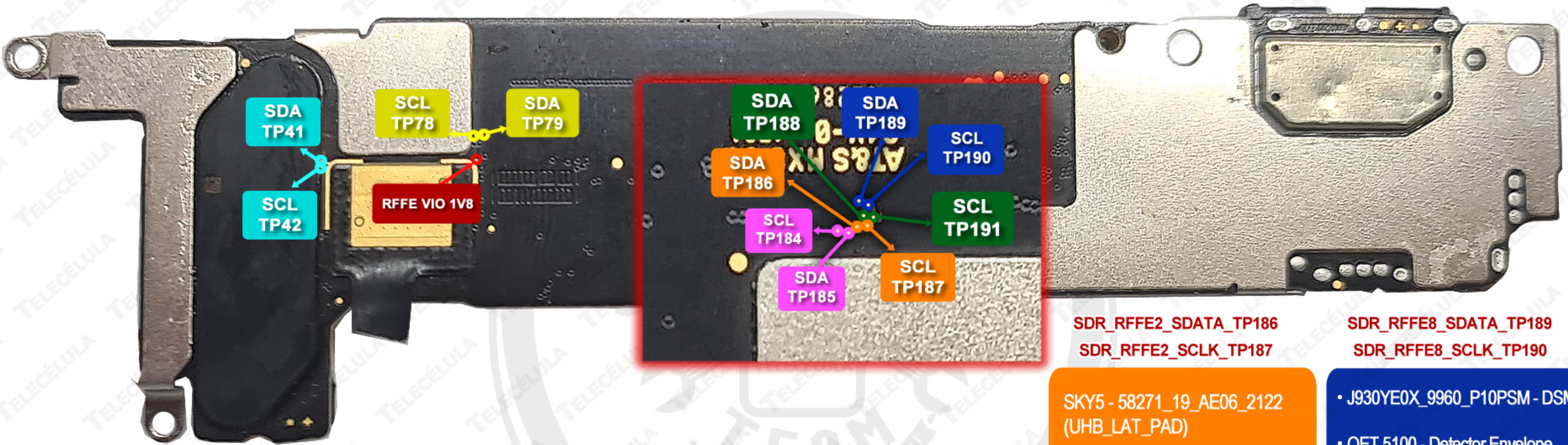

SDR_RFFE2_SDATA_TP186
SDR_RFFE2_SCLK_TP187

SDR_RFFE8_SDATA_TP189
SDR_RFFE8_SCLK_TP190

SKY5 - 58271_19_AE06_2122 (UHB_LAT_PAD)
BRY_E037_OVL4 - ET

• J930YE0X_9960_P10PSM - DSM
• QET 5100 - Detector Envelope

RFFE VIO 1V8 - TP74

RFFE VIO 1V8 - TP74

SDR_RFFE1_SDATA_TP188
SDR_RFFE1_SCLK_TP191

SDR_RFFE3_SDATA_TP185
SDR_RFFE3_SCLK_TP184

SDR_RFFE5_SDATA_TP41
SDR_RFFE5_SCLK_TP42

SDR_RFFE7_SDATA_TP79
SDR_RFFE7_SCLK_TP78

• SKY5 - 7217_7553_2124 (PA-2G) - **0x5**
• AVAGO - 8215_RL006_KM122 (HB PA) - **0x3**
• QET 5100 - **0x4**
• AT - 10 - **0x8**

• (TOP) 0611-7146-2123 - **0xE**
• AVAGO 8215_RL006_KM122-HBPA - **0x3**
• SKY5 140419 - **0xA**
• J930YE0X 9960_P10PSM - DSM - **0x6**
• SKY5 58271-10-AE06 2122 - LBPA - **0x1**

• 0611-2829-2123 (TOP) CI X11 - **0xE**
• SKY5_53838_17 - 3103273_2125MX - UHB_DSM - **0x7**
• AVAGO_8225_KM121 - DSM_UHB_E - **0x3**
• SKY5 14 04 19 - MIMO_LOWER_DSM - **0xA**
• K89 - DSM_LB_E - **0x3**

• SKY5 53838_17 3103273_2125MX - UHB DSM - **0x3**
• BRY B057 OBOC - **0xB**
• SKY5 9723 0080 - TOP (CI X13) - **0x8**

RFFE VIO 1V8 - TP74

RFFE VIO 1V8 - TP74

RFFE VIO 1V8 - TP74

RFFE VIO 1V8 - TP74

SMARTBOARD - IPHONE 13 PRO

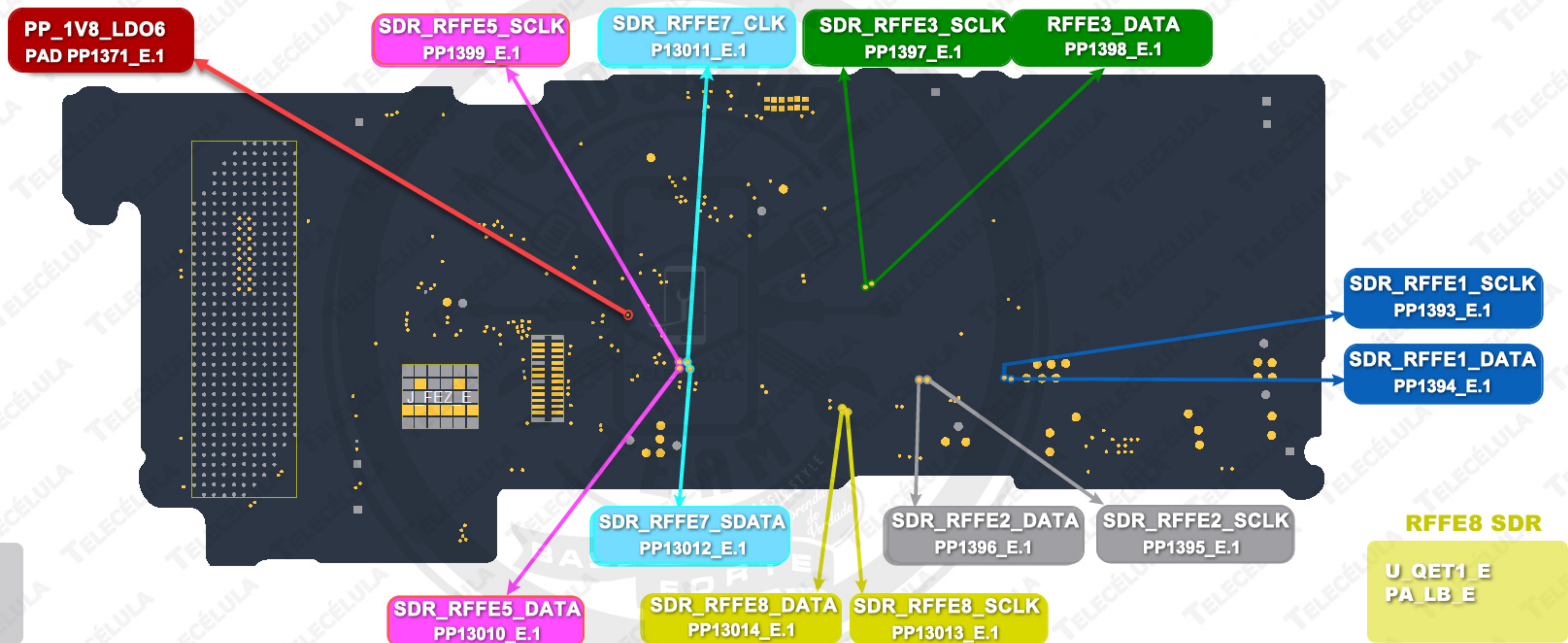

RFFE2 SDR
PAUHBL_E
U_APTL_E

RFFE8 SDR
U_QET1_E
PA_LB_E

RFFE 1 SDR

PA_HB_E	0x3	RFFE1_SDR
PA_LMB_2G_E	0x5	RFFE1_SDR
CPLR_L_E	0x8	RFFE1_SDR
U_QET0_E	0x4	RFFE1_SDR

RFFE 3 SDR

PA_HB_E	0x3	RFFE3_SDR
PA_UHB_L_E	0x6	RFFE3_SDR
MIMO_L_E	0xA	RFFE3_SDR
PA_LB_E	0x1	RFFE3_SDR
U_5G_L_W	0xE	RFFE3_SDR

RFFE 7 SDR

UAPT_L_E	0xB	RFFE5_SDR
CPLR_U_E	0x8	RFFE5_SDR
DSM_HB_E	0x3	RFFE5_SDR

RFFE 5 SDR

U_5G_U_W	0xE	RFFE7_SDR
DSM_UHB_E	0x7	RFFE7_SDR
DSM_LB_E	0x1	RFFE7_SDR
DSM_HB_E	0x3	RFFE7_SDR
MIMO_U_E	0xA	RFFE7_SDR

BOARD TOP

BOARD BOTTOM

SMARTBOARD - IPHONE 13 PRO MAX

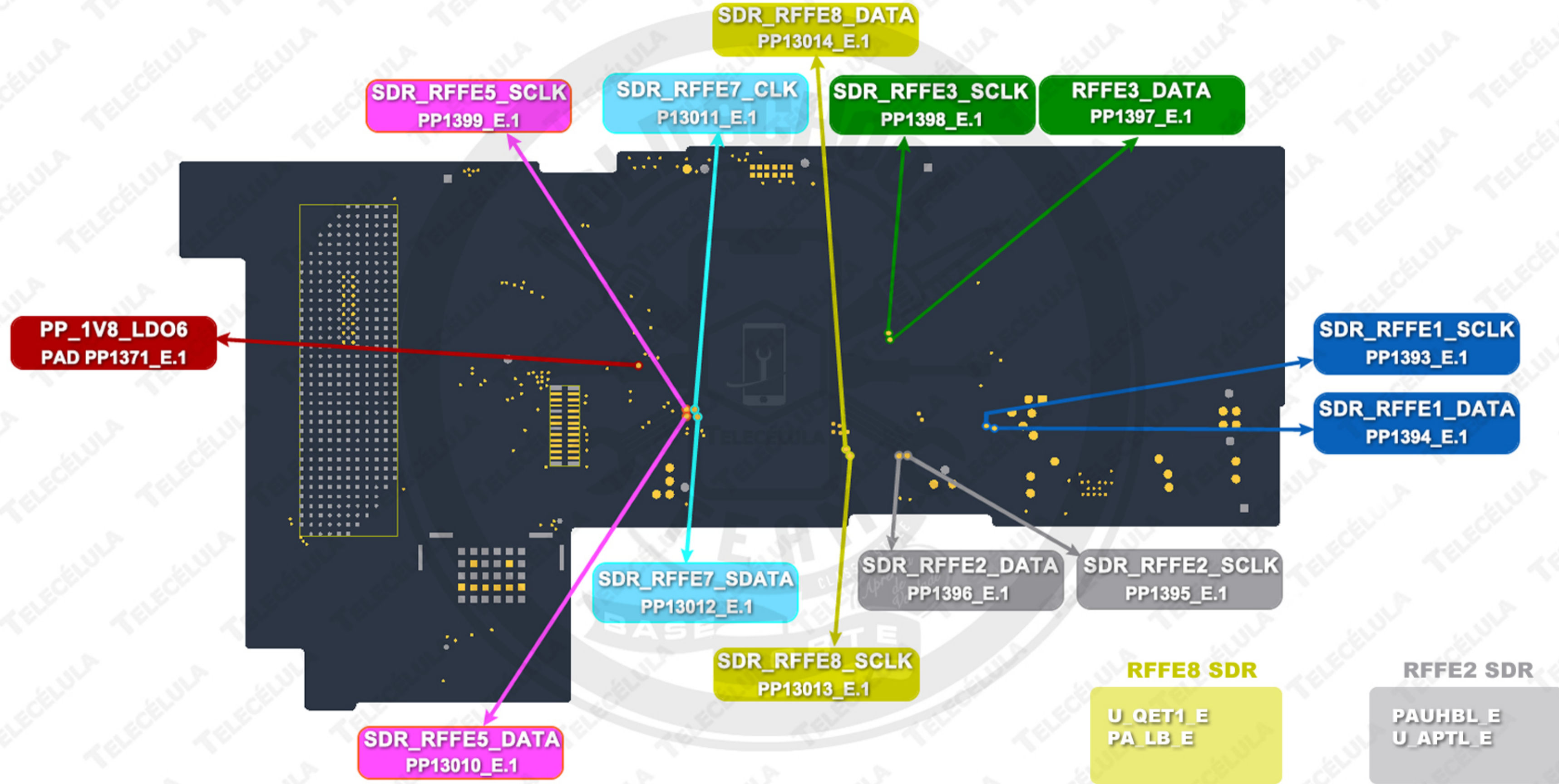

RFFE 1 SDR

PA_HB_E	0x3	RFFE1_SDR
PA_2G_E	0x5	RFFE1_SDR
CPLR_L_E	0x8	RFFE1_SDR
U_QET0_E	0x4	RFFE1_SDR

RFFE 3 SDR

PA_HB_E	0x3	RFFE3_SDR
PA_UHB_L_E	0x6	RFFE3_SDR
MIMO_L_E	0xA	RFFE3_SDR
PA_LB_E	0x1	RFFE3_SDR
U_5G_L_W	0xE	RFFE3_SDR

RFFE 5 SDR

DSM_LB_E	0x3	RFFE7_SDR
DSM_HB_E	0x3	RFFE7_SDR
U_5G_U_W	0xE	RFFE7_SDR
MIMO_U_E	0xA	RFFE7_SDR
DSM_UHB_E	0x7	RFFE7_SDR

RFFE 7 SDR

U_APTU_E	0xB	RFFE5_SDR
CPLR_U_E	0x8	RFFE5_SDR
DSM_HB_E	0x3	RFFE5_SDR

SMARTBOARD - IPHONE 14 PRO/ 14 PRO MAX - VIO



IPHONE 14 PRO (RFFE - SDR)

RFFE-1 SDR

RFFE-3 SDR

RFFE-7 SDR

RFFE-1

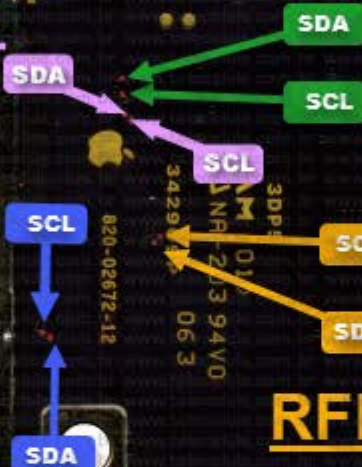

RFFE-6 SDR



RFFE-1

PA UHB (U232)
IF IC (U233)

RFFE-4

X550 - SKY 724 866
X239_1 - DP08
U0590 - SKY 853-17 25068 2225

RFFE-0 SDR

RFFE-2 SDR

RFFE-3 SDR

RFFE-5 SDR

MIMO_U_E 0xA RFFE7_SDR
DSM_UHB 0x7 RFFE7_SDR
DSM_HB_E 0x3 RFFE5_SDR
DSM_LB_E 0x1 RFFE7_SDR
U_5G_U_W 0xE RFFE7_SDR

PA_HB_E 0x3 RFFE1_SDR
U_QET0_E 0x4 RFFE1_SDR
CPLR_L_E 0x8 RFFE1_SDR

PA_LMB 0x5 RFFEE6_SDR
PA_LB_E 0x1 RFFE6_SDR
QET_1 0x4 RFFE6_SDR

MIMO_L_E 0xA RFFE3_SDR
PA_LB_E 0x1 RFFE3_SDR
U_5G_L_W 0xE RFFE3_SDR
PA_HB_E 0x3 RFFE3_SDR
PA_UHB_L_E 0x6 RFFE3_SDR

IPHONE 14 PRO MAX (RFFE - SDR)

RFFE-1 SDR

RFFE-3 SDR

RFFE-7 SDR

RFFE-1

SDA

SDA

SCL

SCL

SCL

SCL

SDA

SCL

SDA

SDA

RFFE-6 SDR



RFFE-1

PA UHB (U232)
IF IC (U233)

RFFE-4

X550 - SKY5 724 866
X239_1 - DP08
U0590 - SKY 853-17 25068 2225

RFFE-0 SDR

RFFE-2 SDR

RFFE-3 SDR

RFFE-5 SDR

MIMO_U_E 0xA RFFE7_SDR
DSM_UHB 0x7 RFFE7_SDR
DSM_HB_E 0x3 RFFE5_SDR
DSM_LB_E 0x1 RFFE7_SDR
U_5G_U_W 0xE RFFE7_SDR

PA_HB_E 0x3 RFFE1_SDR
U_QET0_E 0x4 RFFE1_SDR
CPLR_L_E 0x8 RFFE1_SDR

PA_LMB 0x5 RFFE6_SDR
PA_LB_E 0x1 RFFE6_SDR
QET_1 0x4 RFFE6_SDR

MIMO_L_E 0xA RFFE3_SDR
PA_LB_E 0x1 RFFE3_SDR
U_5G_L_W 0xE RFFE3_SDR
PA_HB_E 0x3 RFFE3_SDR
PA_UHB_L_E 0x6 RFFE3_SDR

IPHONE 15 PRO

MOUNTED BOARD

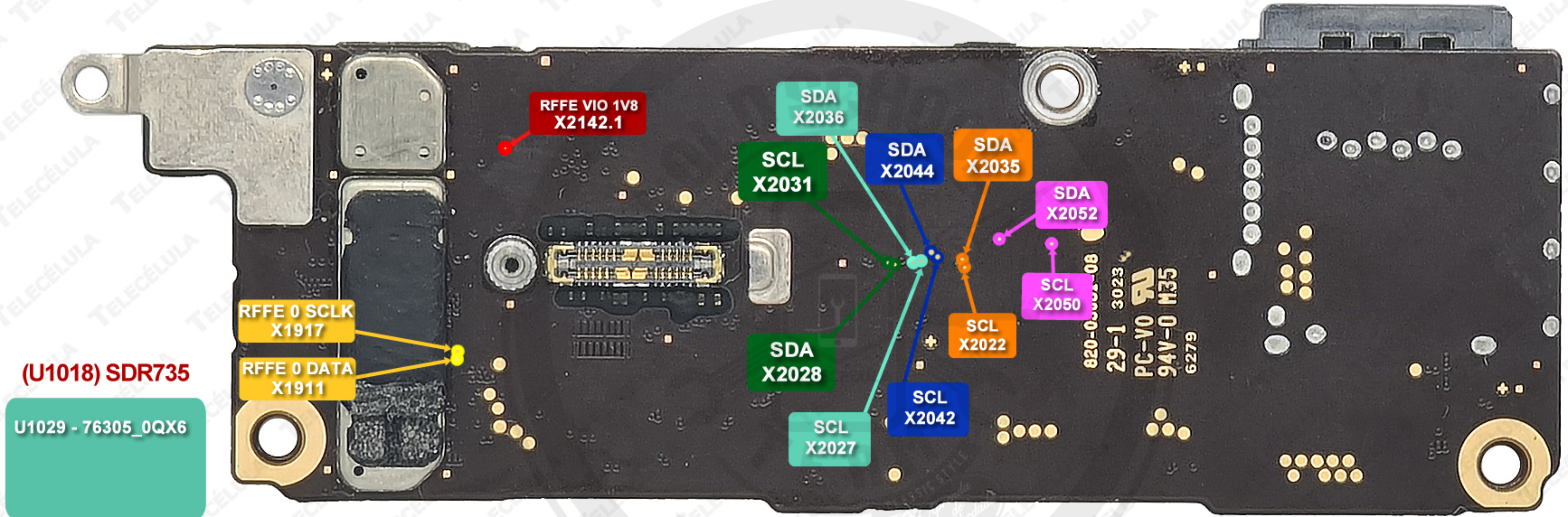

(U1018) SDR735

U1029 - 76305_0QX6

SDR1_RFFE1

(U1018) SDR735

U1035-8249_TM025_KA324_
(UHB_PA) 0xB
U1004 - SKY5_04516
X10011 - 151
U1010 - L14
U1003 - SKY5 031324452320

SDR1_RFFE0

(U1018) SDR735

U1025_SKY5 8446 - 0x1
(LB_PA)
U1026_SKY5 921682692 - 0x5
U1032_QET7100
(DETECTOR ENVELOPE) - 0x4

SDR1_RFFE3

(U1018) SDR735

U1001_SKY5 724-702
U1003_SKY5 031324452320
0x3 - (HB DSM)
U1035_8249_TM025_KA324_
(UHB_PA) 0xB
U1011 - F0CZ

SDR1_RFFE4

(U1018) SDR735

U1031_155 - 0x8
U1021_QET7100 - 0x4
(DETECTOR ENVELOPE)
U1023_AVAGO 8234 - 0X3

SDR1_RFFE2

(U1018) SDR735

U1023 - AVAGO 8234 - 0x3
U1024 - SKY5 04516 - 0xA
U1025 - SKY5 58446-11-FEM - 0x1
U1029 - 76305-0QX6 - 0x6
X10802 (TOP BOARD) 0xE

SDR1_RFFE5